



Non
bestemmiare
adopera USAG
utensili professionali

100
Anni
1926

**SUPER
OFFERTA
2026**

€ Senza IVA 66/2026
Valida fino al 28/02/2027



LA CASA ROSSA



**QUALCOSA STA
PER ACCADERE...**

INQUADRA IL QR



STAY TUNED



La monografia

USAG compie 100 anni di storia, passione e innovazione.

Per festeggiare questo anniversario abbiamo scelto di fare qualcosa di speciale: una **monografia originale, fuori dagli schemi**, pensata e realizzata appositamente per te. Non un semplice racconto celebrativo, ma un progetto capace di sorprenderti e di offrirti un'esperienza diversa dal solito.

Sei curioso vero? Cerca la **monografia USAG**: potresti scoprire qualcosa di inatteso, che racchiude molto di più di quanto immagini!



Atto di costituzione della Società



La storia dei nostri 100 anni

L'azienda nasce a Gemonio il 1° aprile 1926 per iniziativa di Anselmo Quadrelli e Teresita Luraschi. Fin dall'inizio la produzione di utensili manuali prende vita nella "Ca' Rossa", su un terreno ceduto dallo stesso Quadrelli.

Nel 1930, con l'uscita del fondatore, la società assume il nome di "Utensileria Società Anonima Gemonio" (USAG). Il 1937 segna una svolta decisiva: l'azienda viene acquisita da Hermann Amos, imprenditore di origine tedesca nato ad Aquileia e residente a Milano, che avvia l'ampliamento dello stabilimento.

Dal 1947 al 1991 la guida passa al figlio Giulio Amos, protagonista della crescita di USAG durante il boom economico italiano, grazie a utensili di grande qualità e affidabilità.

Nel 1991 USAG viene ceduta al Gruppo francese Facom; nel 2006 passa al gruppo americano STANLEY e, dal 2010, entra a far parte di StanleyBlack&Decker, assetto ancora oggi esistente e operante sul mercato.

In questo contesto multinazionale, l'azienda ha saputo mantenere la propria identità e autonomia, rafforzandosi attraverso sinergie produttive, tecnologiche, commerciali e di Marketing.

SCOPRI LE NOVITÀ 2026



Novità

XGRIP Pagina 6



Iconic Product

Pagina 46



Novità

JUST Pagina 92



Novità

Carrelli portautensili
Pagina 18



Novità

Arredamento da officina
Pagina 28



Novità

Banchi da lavoro
Pagina 32



Novità

Altri carrelli
Pagina 36



Contenitori trasportabili
Pagina 37



Assortimenti
Pagina 40



Novità

Valigie manutenzione
Pagina 44



Giraviti
Pagina 48



Inseri e chiavi maschio
Pagina 50



Chiavi di manovra
Pagina 52



Novità

Pinze e tronchesi
Pagina 54



Cricchetti e bussole
Pagina 60



Novità

Serraggio controllato
Pagina 62



Illuminazione
Pagina 65



Elettrotecnica
Pagina 66



Novità

Manutenzione
Pagina 68



Novità

Estrattori
Pagina 72



Autoreparazione
Pagina 76



Pneumatica e accessori
Pagina 84



Novità

Comfort e protezione
Pagina 91

TUTTI I VANTAGGI DELLA TECNOLOGIA X-Grip



VITI DANEGGIATE

X-Grip ti permette di lavorare con efficacia sia su viti nuove che molto danneggiate: l'utensile non perderà la sua presa sulla vite, riuscendo a farti proseguire nel tuo lavoro.



TRASMISSIONE DELLA COPPIA

La presa che il profilo X-Grip esercita sulla testa di una vite nuova, permette di trasmettere una coppia di serraggio maggiore rispetto ai profili standard. Un vero vantaggio in caso di vite nuova serrata con una coppia alta e quindi difficile da sbloccare.



PREVIENE IL DANNEGGIAMENTO

I profili X-Grip sono progettati per prevenire il danneggiamento dei profili delle viti nuove. Utilizzando utensili X-Grip, le viti nuove avranno una durata maggiore.



YouTube



YouTube

CHIAVI COMBinate 285 X

FORCHETTA INCLINATA

Angolo di 15° rispetto all'asse della chiave.

SEZIONE A DOPPIA T

Massima resistenza alla flessione.

OCCHIO DISASSATO

Per dadi e bulloni incassati in posizioni di difficile accesso.

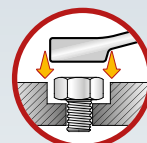

30% PIÙ LUNGA

DI UNA NORMALE CHIAVE 285

Questo permette di applicare una coppia del 30% superiore rispetto alla chiave standard.



PROFILO SPECIALE X-Grip

Efficace anche su viti molto danneggiate. Su viti nuove trasmette una coppia maggiore e preserva la durata del profilo della vite.



8 PEZZI

8÷19 mm



285 X/B8

U02850950

Serie di 8 chiavi combinate X-Grip

- 285 X/8-10-11-12-13-14-17-19 mm.
- Fornita in busta in tessuto in altissima resistenza.

~~111,00 €~~

79,00 €

12 PEZZI

8÷19 mm



285 X/B12

U02850951

Serie di 12 chiavi combinate X-Grip

- 285 X/8-9-10-11-12-13-14-15-16-17-18-19 mm.
- Fornita in busta in tessuto in altissima resistenza.

~~171,00 €~~

116,00 €

8 PEZZI

8÷19 mm



Novità

285 X/DS8

U02850954

Serie di 8 chiavi combinate X-Grip

- 285 X/8-10-13-14-15-16-17-19 mm.
- Fornita con supporto in materiale plastico.

~~116,00 €~~

79,00 €

14 PEZZI

6÷19 mm



Novità

285 X/DS14

U02850955

Serie di 12 chiavi combinate X-Grip

- 285 X/6-7-8-9-10-11-12-13-14-15-16-17-18-19 mm.
- Fornita con supporto in materiale plastico.

~~193,00 €~~

119,00 €

BUSSOLE 235 X E 235 XL



YouTube

ACCIAIO SPECIALE

altamente legato al cromo vanadio.
Esecuzione cromata.



PROFILO SPECIALE X-Grip

Efficace anche su viti molto danneggiate. Su viti nuove trasmette una coppia maggiore e preserva la durata del profilo della vite.

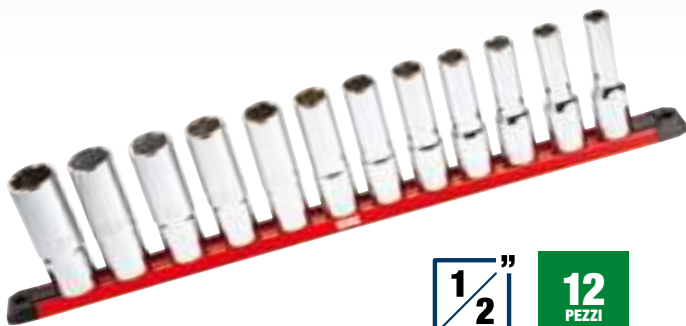

$\frac{1}{2}$ " 12 PEZZI

235 1/2" XL/SE12

U02354101

Serie di 12 chiavi a bussola con bocca esagonale speciale X-Grip

~~113,00 €~~ **83,00 €**

10-11-12-13-14-15-16-17-18-19-21-22 mm

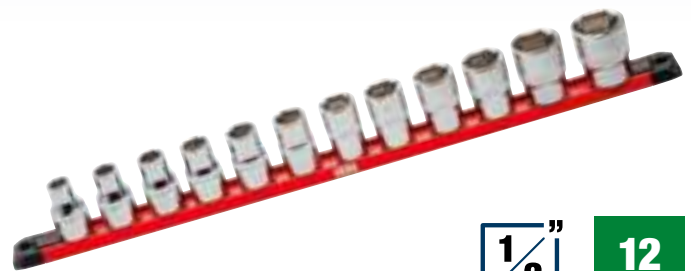

$\frac{1}{2}$ " 12 PEZZI

235 1/2" X/SE12

U02350501

Serie di 12 chiavi a bussola con bocca esagonale speciale X-Grip

~~113,00 €~~ **81,00 €**

10-11-12-13-14-15-16-17-18-19-22-24 mm



$\frac{1}{4}$ " 10 PEZZI

235 1/4" X/SE10

U02350500

Serie di 10 chiavi a bussola con bocca esagonale speciale X-Grip

~~66,00 €~~ **42,00 €**

5,5-6-7-8-9-10-11-12-13-14 mm

GUIDA MAGNETICA PORTABUSSOLE 559 A

- Base magnetica protetta da strato in gomma: non rovina la superficie.
- Clip orientabile a 360°, per identificare velocemente la bussola.



BUSSOLE 234 X E 234 MX PER VITI CON ESAGONI INCASSATI.

ACCIAIO SPECIALE

altamente legato al cromo molibdeno.
Esecuzione brunita.



ACCIAIO SPECIALE
altamente legato
Esecuzione cromata.

PROFILO SPECIALE X-Grip

*Efficace anche su viti molto danneggiate.
Su viti nuove trasmette una coppia maggiore e preserva la durata del profilo della vite.*

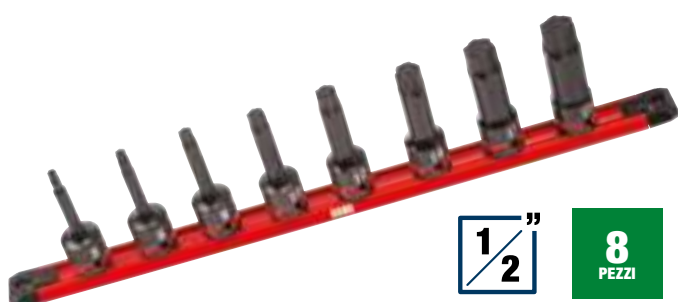

$\frac{1}{2}$ " 8 PEZZI



234 1/2''MX/SE8 U02340850

Serie di 8 chiavi a bussola macchina con profilo esagonale speciale X-Grip per viti con esagono incassato

~~210,00 €~~

149,00 €

5-6-8-10-12-
14-17-19 mm



$\frac{1}{2}$ " 8 PEZZI



234 1/2''X/SE8 U02342150

Serie di 8 chiavi a bussola con profilo esagonale speciale X-Grip per viti con esagono incassato

~~192,00 €~~

135,00 €

5-6-8-10-12-
14-17-19 mm

**L'EFFICACIA
DI X-Grip.
LA POTENZA
DEGLI IMPULSI.**



**BUSSOLE PER
CRICCHETTO CON
INSERTO INTEGRATO.**



PROFILO SPECIALE X-Grip

*Efficace anche su viti molto danneggiate.
Su viti nuove trasmette una coppia maggiore e preserva la durata del profilo della vite.*



6
PEZZI



YouTube

2,5-3-4-5-6-8 mm

280 HX/SE6

U02802460

Serie di 6 chiavi maschio con profilo esagonale speciale X-Grip e impugnatura bimatériale

- 280 HX/2,5-3-4-5-6-8 mm.
- Impugnatura ergonomica bimatériale con rivestimento antiscivolo.
- Design studiato per una presa sicura durante la manovra.
- Acciaio speciale altamente legato.
- Finitura zinco fosfatata per un'elevata resistenza alla corrosione.

~~107,00 €~~ **74,00 €**



9
PEZZI



YouTube

1,5-2-2,5-3-4-5-6-8-10 mm

280 X/S9

U02800485

Set di 9 chiavi maschio con profilo esagonale speciale X-Grip

- 280 X/1,5-2-2,5-3-4-5-6-8-10 mm.
- Modello che permette di operare con inclinazioni fino a 25% rispetto all'asse della vite.
- Acciaio speciale altamente legato.
- Finitura zinco fosfatata per un'elevata resistenza alla corrosione.
- Supporto in plastica.

~~79,50 €~~ **54,00 €**



9
PEZZI



YouTube

2-2,5-3-4-5-6-7-8 mm

 **1/4"**
Bussola portainseri

660 X/B9

U06600100

 **110**
20
mm **105**

Set di inserti con profilo esagonale speciale X-Grip

- Profilo esclusivo per esagoni incassati: permette di fare presa su esagoni incassati intatti o completamente danneggiati fino al 92%.
- In acciaio speciale con finitura fosfatata.
- Inclusa bussola portainseri 1/4-1/4".
- Fornito in astuccio di tessuto compatto.

DESCRIZIONE	ART./MISURA	PZ.
Inserti con profilo speciale	660 X 2-2,5-3-4-5-6-7-8	8
Bussola portainseri	684 1/4	1

~~57,00 €~~ **37,00 €**



PROFILO SPECIALE X-Grip
 Efficace anche su viti molto danneggiate.
 Su viti nuove trasmette una coppia
 maggiore e preserva la durata
 del profilo della vite.



Novità

280 HXTX/SE8

U02802451

Serie di 8 chiavi maschio con profilo TORX® speciale X-Grip e impugnatura bimateriale

- Impugnatura ergonomica bimateriale con rivestimento antiscivolo.
- Design studiato per una presa sicura durante la manovra.
- Acciaio speciale altamente legato.
- Finitura zinco fosfatata per un'elevata resistenza alla corrosione.

~~134,00 €~~

94,00 €

8
PEZZI



**T8-T10-T15-T20-
T25-T27-T30-T40**



280 HXTX/SE6

U02802450

Serie di 6 chiavi maschio con profilo TORX® speciale X-Grip e impugnatura bimateriale

- Impugnatura ergonomica bimateriale con rivestimento antiscivolo.
- Design studiato per una presa sicura durante la manovra.
- Acciaio speciale altamente legato.
- Finitura zinco fosfatata per un'elevata resistenza alla corrosione.

~~97,00 €~~

68,00 €

6
PEZZI



T8-T10-T15-T20-T25-T30

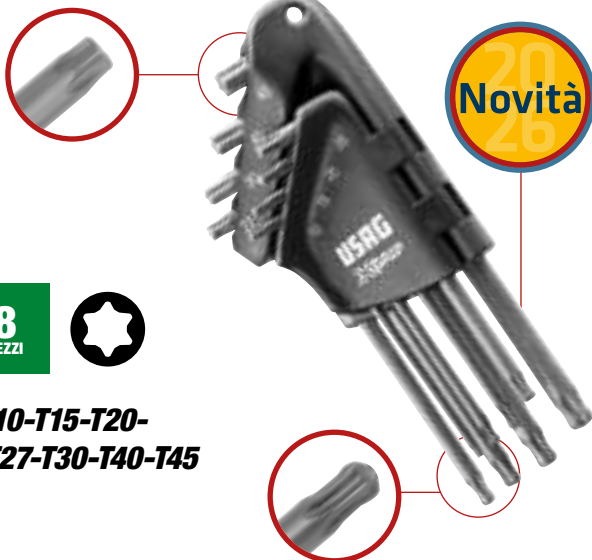

Novità

280 XTX/S8

U02800080

Serie di 8 chiavi maschio lunghe a testa sferica con profili TORX® speciali X-Grip

- Acciaio speciale altamente legato.
- Finitura zinco fosfatata per un'elevata resistenza alla corrosione.
- Supporto in plastica.

~~85,00 €~~

59,00 €

8
PEZZI



**T10-T15-T20-
T25-T27-T30-T40-T45**



28
PEZZI

Novità

Portainseriti



660 XTE/S28

U06600113

Set di inserti con profilo esagonale e TORX® speciali X-Grip

- In acciaio speciale con finitura fosfatata.
- Supporto in plastica.

~~153,00 €~~ **99,00 €**

 1,5-2-2,5-3-4-5-
5,5-6-7-8-9-10 mm

 5-6 mm

 T6-T7-T8-T9-T10-T15-T20-T25-
T27-T30-T40-T45-T47-T50



11
PEZZI

Novità

Portainseriti



660 X/S11

U06600111

Set di inserti con profilo esagonale speciale X-Grip

- In acciaio speciale con finitura fosfatata.
- Supporto in plastica.

~~59,50 €~~ **39,00 €**

 2-2,5-3-4-5-6-
7-8-9-10 mm



11
PEZZI

Novità

Portainseriti



660 XSTX/S11

U06600112

Set di inserti TORX® con profilo speciale X-Grip

- In acciaio speciale con finitura fosfatata.
- Supporto in plastica.

~~60,00 €~~ **39,00 €**

 T6-T8-T10-T15-T20-T25-
T27-T30-T40-T50



SISTEMA DI ESTRAZIONE RAPIDA

I supporti per inserti si distinguono per il loro avanzato sistema di estrazione, che permette di rimuovere rapidamente e in sicurezza gli inserti e i portainseriti con una sola mano.

PINZA UNIVERSALE 151 X

GANASCE SPECIALI PER VITI E FILETTI DANNEGGIATI.

**TAGLIENTI TEMPRATI
AD INDUZIONE**

TESTA COMPATTA
per un'ottima accessibilità.

**IMPUGNATURE ERGONOMICHE
BIMATERIALI**

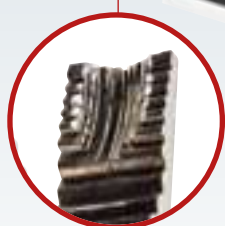

GANASCE CON PROFILO INTERNO SPECIALE

*Permettono una presa frontale su
diametri fino a 15 mm.
Efficace anche con poco materiale
residuo su cui fare presa.*



151 X
U01510160

Pinza universale con ganasce speciali X-Grip

- Ganasce con profilo interno speciale per la presa frontale di viti o barre filettate fino ad un diametro di 15 mm.
- Ideale anche per la presa frontale di piccoli esagoni.
- Efficace anche su materiale piatto, grazie ai 4 punti di contatto frontali.
- Incavo dentato laterale per presa di materiale tondo o esagonale.
- Taglienti ulteriormente temprati ad induzione.
- Testa compatta per un'ottima accessibilità.
- Permettono il taglio di filo metallico dolce, di media durezza e duro.
- Cerniera aperta con articolazione forgiata.
- Impugnature ergonomiche bimateriali.
- Esecuzione brunita con superfici fresate.

51,50 €

36,00 €

**GANASCE UNIVERSALI
MULTIPRESA CON
TAGLIANTE INTEGRATO**

GAMMA ASSORTIMENTI X-Grip IN CASSETTA

Con all'interno inserti esagonali, inserti Torx e bussole X-Grip.

PROFILO SPECIALE X-Grip

Efficace anche su viti molto danneggiate.

Su viti nuove trasmette una coppia maggiore e preserva la durata del profilo della vite.

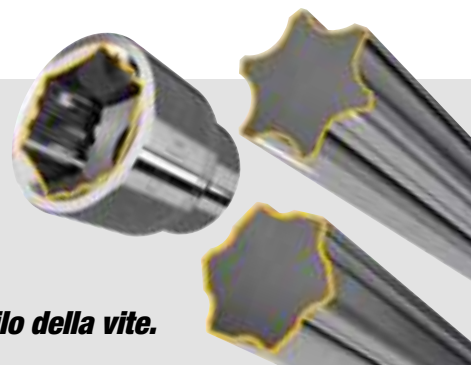

Inserto portabussole

23
PEZZI

1/4"

1/4"



YouTube



609 1/4" SKX

U06090004

134 g | mm | 120
30
60

Assortimento con bussole esagonali speciali X-Grip ed inserti per avvitatura

- Cassetta in bimatereale con rivestimento soft-touch.
- Marcatura interna delle bussole contenute.
- Clip di aggancio in metallo.

DESCRIZIONE	ART./MISURA	PZ.
Cricchetto reversibile con prolunga	237 1/4" SK	2
Chiavi a bussola con bocca esagonale speciale	235 1/4" X 6-8-10-12-13	5
Inserti ad intaglio	660 0,5x4	1
Inserti a croce Phillips®	660 PH 2	1
Inserti a croce Pozidriv®- SUPadriv®	660 PZ 2	1
Inserto portabussole	660 Q 1/4"	1
Inserti TORX® Tamper Resistant X-Grip	660 XSTX T20-T25-T30-T40	4
Inserti con profilo esagonale X-Grip	660 X 2-2,5-3-4-5-6-7-8	8

~~138,00 €~~ **82,00 €**



38
PEZZI

1/4"

1/4"



609 1/4" EAX

U06090003

900 g | mm | 155
50
95

Assortimento con bussole esagonali speciali X-Grip ed inserti per avvitatura

- Cassetta in bimatereale con rivestimento soft-touch.
- Marcatura interna delle bussole contenute.
- Clip di aggancio in metallo.

DESCRIZIONE	ART./MISURA	PZ.
Chiavi a bussola con bocca esagonale X-Grip	235 1/4" X 5,5-6-7-8-9-10-11-12-13-14 mm	10
Prolunghe	236 1/4" 50-100	2
Cricchetto reversibile	237 A 1/4"	1
Snodo cardanico	241 1/4"	1
Impugnatura porta-bussole	243 1/4"	1
Inserti ad intaglio	660 0,6x4,5-1x5,5-1,2x6,5	3
Inserti PH	660 PH 1-2-3	3
Inserti PZ	660 PZ 1-2-3	3
Inserti con profilo esagonale X-Grip	660 X 2-3-4-5-6	5
Inserti TORX® Tamper Resistant X-Grip	660 XSTX T10-T15-T20-T25-T27-T30-T40	7
Inserto porta-bussole	660 Q 1/4"	1
Bussola porta-inserti	684 1/4"-1/4"	1

~~231,00 €~~ **149,00 €**

8-10-11-12-13-14-15-16-17-18-
19-21-22-24-27-30-32 mm



MANIGLIA IN ACCIAIO

la prolunga contenuta nell'assortimento diventa la maniglia di trasporto

1 1/2"

21
PEZZI



Sistema che permette di tenere sempre sotto controllo il contenuto dell'assortimento



Marcatura interna delle bussole contenute

609 1/2" EAX
U06090027

3,7 kg | 335 mm | 55 mm | 180

Assortimento in cassetta bimateriale con bussole esagonali speciale X-Grip

- Cassetta in bimateriale con rivestimento soft-touch.
- Marcatura interna delle bussole contenute.
- Clip di aggancio in metallo.
- Modularità: la cassetta ha le dimensioni di un modulo portautensili e può essere alloggiata nei cassettei H60 mm dei carrelli

DESCRIZIONE	ART./MISURA	PZ.
Chiavi a bussola con bocca esagonale X-Grip	235 1/2" X 8-10-11-12-13-14-15-16-17-18-19-21-22-24-27-30-32 mm	17
Prolunghe	236 1/2" 125-200	2
Cricchetto reversibile certificato IP 51	237 A 1/2"	1
Snodo cardanico	241 1/2"	1

~~277,00 €~~

169,00 €

1 1/2"

5
PEZZI

235 1/2" XL/C5
U02353900

1 kg | 180 mm | 44 mm | 115

Assortimento in cassetta bimateriale con bussole lunghe con bocca esagonale speciale X-Grip

- Cassetta in bimateriale con rivestimento soft-touch.
- Marcatura interna delle bussole contenute.
- Clip di aggancio in metallo.

~~55,50 €~~

39,00 €



15-17-19-21-22 mm





519 M 613CEAX

U05191068

22
PEZZI

235 1/2" X 8-10-11-12-13-14-15-16-17-18-19-21-22-24-27-30-32 mm · 236 1/2" 125-250 mm · 237 A 1/2" · 240 1/2" N · 241 1/2".

~~286,00 €~~

200,00 €



519 M 613AEAX

U05191069

41
PEZZI

235 1/4" X 5,5-6-7-8-9-10-11-12-13-14 mm · 236 1/4" 50-100 mm · 237 A 1/4" · 240 1/2" N · 241 1/4" · 243 1/4" · 280 X/S9" · 660 X 2-2,5-3-4-5-6-7-8 mm · 660 XSTX T10-T15-T20-T25-T27-T30-T40 · 684 1/4".

~~317,00 €~~

222,00 €

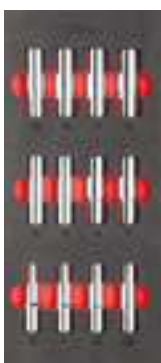

519 M 235XL

U05191067

12
PEZZI

235 1/2" XL 10-11-12-13-14-15-16-17-18-19-21-22 mm.

~~115,00 €~~

84,00 €



519 M 234X

U05191017

16
PEZZI

234 1/2" X 5-6-8-10-12-14-17-19 mm · 234 1/2" MX 5-6-8-10-12-14-17-19 mm.

~~401,00 €~~

280,00 €



519 M 285X

U05191063

12
PEZZI

285 X 8-9-10-11-12-13-14-15-16-17-18-19 mm.

~~178,00 €~~

122,00 €



519 M 280HX

U05191064

6
PEZZI

280 HX 2,5-3-4-5-6-8 mm.

~~119,00 €~~

83,00 €

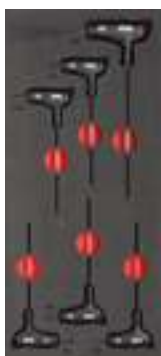

519 M 280HXTX

U05191066

6
PEZZI

280 HXTX T8-T10-T15-T20-T25-T30.

~~109,00 €~~

75,00 €

**Vuoi creare il tuo
assortimento aggiungendo
altri moduli?
Vai a pagina 42**

ASSORTIMENTO MANUTENZIONE



Novità
2026

Moduli X-Grip



519 M 280HXTX



519 M 280HX



519 M 234X



519 M 613AEAX



519 M 613CEAX



519 M 235 XL



519 M 127N



519 M 150AX



519 M 285X



519 M 990A5MD



519 M 382F



519 M 324H

516 ST6MXG

U05160639

RAL
3020

Carrello START con assortimento X-Grip Manutenzione - 4 cassetti

2.931,00 €

1.449,00 €

144
PEZZI



6
CASSETTI

3
MODULI

516 ST6NMXG

U05161639

RAL
9005

Carrello START con assortimento X-Grip Manutenzione - 4 cassetti

2.931,00 €

1.449,00 €

RISPARMI
300 €

DESCRIZIONE

DESCRIZIONE	ART	PZ
Pinze per anelli elastici interni ed esterni 19÷60	519 M 127N	4
Pinza universale, pinza regolabile, tronchese, pinza becchi lunghi e pinza grip	519 M 150AX	5
Bussole e bussole macchina esagonali X-Grip (5-6-8-10-12-14-17-19 mm)	519 M 234X	16
Bussole esagonali lunghe 1/2 X-Grip (10-11-12-13-14-15-16-17-18-19-21-22 mm)	519 M 235XL	12
Chiavi maschio esagonali con impugnatura X-Grip (2,5-3-4-5-6-8 mm)	519 M 280HX	6
Chiavi maschio TORX® con impugnatura X-Grip (T8-T10-T15-T20-T25-T30)	519 M 280HXTX	6
Chiavi combinate X-Grip (8-9-10-11-12-13-14-15-16-17-18-19 mm)	519 M 285X	12
Giraviti per viti ad intaglio ed a croce PHILLIPS	519 M 324H	8
Martello per meccanici, mazzuola, cacciaspine, scalpello e bullino	519 M 382F	7
Bussole esagonali X-Grip, cricchetto (237 A) ed accessori 1/2	519 M 613AEAX	41
Bussole esagonali X-Grip, cricchetto (237 A), accessori 1/4, inserti X-Grip e chiavi maschio X-Grip	519 M 613CEAX	22
Lima piatta, mezzatonda, tonda, quadra, triangolare	519 M 990A5MD	5

Moduli X-Grip



519 M 280HXTX



519 M 280HX



519 M 234X



519 M 613AEAX



519 M 613CEAX



519 M 235 XL



519 M 127N



519 M 150AX



519 M 285X



519 M 990A5MD



519 M 382F



519 M 324H

495 MXG

U04950639

Assortimento X-Grip MANUTENZIONE - 4 cassetti

2.150,00 €

1.210,00 €

144
PEZZI



Novità
2026



CARRELLO 519 RACING LA TUA POSTAZIONE DI LAVORO AL TOP.



**DUE RUOTE
CON FRENO**

Piano di lavoro ampio
con doppia maniglia



Doppio strato
Sopra: lastra in alluminio da 2 mm.
Sotto: piano in legno da 15 mm.



Paraurti in gomma su
telaio e cassetti.



Maniglie ergonomiche
basculanti in alluminio



Risparmia il tuo tempo

Tutti i carrelli a cassetta USAG sono subito pronti all'uso, perchè forniti con le ruote già montate alla struttura.



900 kg

8
CASSETTI

3
MODULI



900 kg

7
CASSETTI

3
MODULI



900 kg

6
CASSETTI

3
MODULI



519 RS6/3V
U05190506

RAL
3020

Carrello RACING (vuoto)

519 RS8/3V
U05190508

RAL
3020

Carrello RACING (vuoto)

- Dimensioni interne:
 - 6 cassetti 570x420x60 mm.
 - 2 cassetti 570x420x130 mm.

~~1.463,00 €~~ **€ 1.024,00**

519 RS7/3V
U05190507

RAL
3020

Carrello RACING (vuoto)

- Dimensioni interne:
 - 5 cassetti 570x420x60 mm.
 - 1 cassetto 570x420x130 mm.
 - 1 cassetto 570x420x200 mm.

~~1.346,00 €~~ **942,00 €**

519 RS6/3NV
U05190516

RAL
9005

Carrello RACING (vuoto)

- Dimensioni interne:
 - 4 cassetti 570x420x60 mm.
 - 1 cassetto 570x420x130 mm.
 - 1 cassetto 570x420x270 mm.

~~1.226,00 €~~ **858,00 €**

1000 kg



6
CASSETTI

4
MODULI

89 kg

mm

→ 1004
↑ 1005
↘ 575

519 RS6/4V
U05190546

RAL
3020

Carrello RACING (vuoto)

519 RS6/4NV
U05190566

RAL
9005

Carrello RACING (vuoto)

- Dimensioni interne:
 - 4 cassetti 760x420x60 mm.
 - 1 cassetto 760x420x130 mm.
 - 1 cassetto 760x420x270 mm.

~~1.429,00 €~~

999,00 €

1100 kg



7
CASSETTI

5
MODULI

106 kg

mm

→ 1194
↑ 1035
↘ 575

519 RS7/5V
U05190556

RAL
3020

Carrello RACING (vuoto)

- Dimensioni interne:
 - 5 cassetti 950x420x60 mm.
 - 1 cassetto 950x420x130 mm.
 - 1 cassetto 950x420x200 mm.

~~1.871,00 €~~

1.309,00 €

1100 kg



7
CASSETTI

3
MODULI

106 kg

mm

→ 1194
↑ 1035
↘ 575

519 RB07/3V
U05190097

RAL
3020

Carrello RACING con anta laterale (vuoto)

- Dimensioni interne:
 - 5 cassetti 570x420x60 mm.
 - 1 cassetto 570x420x130 mm.
 - 1 cassetto 570x420x200 mm.
- Vano laterale: 380x400x720 mm.

~~1.871,00 €~~

1.309,00 €





NON TROVI IL TUO Configuralo su



6
CASSETTI

3
MODULI

RISPARMI
250 €

Rispetto all'acquisto di carrello ed assortimento separati.



6
CASSETTI

3
MODULI

RISPARMI
250 €

Rispetto all'acquisto di carrello ed assortimento separati.

156
PEZZI



519 RS6/3MM

U05190628

RAL 3020

519 RS6/3NMM

U05191628

RAL 9005

Carrello RACING con assortimento MANUTENZIONE - 4 cassette

~~2.830,00 €~~ **1.368,00 €**

155
PEZZI



519 RS6/3MA

U05190627

RAL 3020

519 RS6/3NMA

U05191627

RAL 9005

Carrello RACING con assortimento AUTORIPARAZIONE - 3 cassette

~~2.811,00 €~~ **1.368,00 €**

ASSORTIMENTO MANUTENZIONE



519 M 613AEA 519 M 613CEA 519 M 285A1



519 M 127C 519 M 150AX 519 MSK6



519 M 324H 519 M 324STX 519 MSK6+ 692 J32



519 M 990A5B 519 M 382 519 MSK6

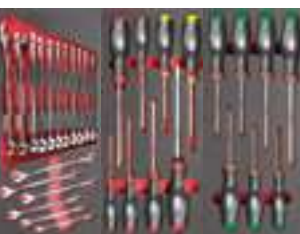

519 M 285A1 519 M 324H 519 M 324STX



519 M 613AEA 519 M 612CLA

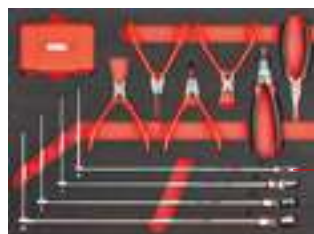

519 M 276C



CHIAVI A T SNODATE
8-10-13-17 mm

DESCRIZIONE

DESCRIZIONE	ART	PZ
Bussole esagonali, cricchetto (237 A), accessori 1/4 ed inserti	519 M 613AEA	46
Bussole esagonali, cricchetto (237 A) ed accessori 1/2	519 M 613CEA	23
Chiavi combinate (6-7-8-9-10-12-13-14-15-16-17-18-19-22-24 mm)	519 M 285A1	17
Pinze per anelli elastici interni ed esterni 15÷25 e 19÷60	519 M 127C	6
Pinza universale, pinza regolabile, tronchese, pinza becchi lunghi e pinza grip	519 M 150AX	5
Giraviti per viti ad intaglio ed a croce PHILLIPS	519 M 324H	7
Giraviti per viti TORX	519 M 324STX	8
Lime a taglio mezzodolce	519 M 990A5B	5
Martello per meccanici, mazzuola, cacciaspine, scalpello e bulino	519 M 382F	7
Assortimento di inserti con cricchetto reversibile	692 J32	32

DESCRIZIONE

DESCRIZIONE	ART	PZ
Bussole esagonali, cricchetto (237 A), accessori 1/4 ed inserti	519 M 613AEA	46
Bussole esagonali lunghe e corte, cricchetto (237 A) ed accessori 1/2	519 M 612CLA	35
Chiavi combinate (6-7-8-9-10-12-13-14-15-16-17-18-19-22-24 mm)	519 M 285A1	17
Giraviti per viti ad intaglio ed a croce PHILLIPS	519 M 324H	7
Giraviti per viti TORX	519 M 324STX	8
Pinze per anelli elastici, pinza universale, pinza becchi lunghi, chiavi snodate con bussola esagonale (8-10-13-17 mm), assortimento di inserti con cricchetto	519 M 276C	42

Vuoi solo l'assortimento? Vai a pagina 40

ASSORTIMENTO IDEALE?

kitplanner.usag.it



6
CASSETTI

4
MODULI

RISPARMI
410 €

Rispetto all'acquisto di carrello ed assortimento separati.



6
CASSETTI

4
MODULI

RISPARMI
410 €

Rispetto all'acquisto di carrello ed assortimento separati.

301
PEZZI



519 RS6/4MM

U05190632

RAL 3020

Carrello RACING con assortimento MANUTENZIONE - 4 cassette

~~4.225,00 €~~

2.079,00 €

301
PEZZI



519 RS6/4NMM

U05191632

RAL 9005

Carrello RACING con assortimento MANUTENZIONE - 4 cassette

~~4.225,00 €~~

2.079,00 €

ASSORTIMENTO MANUTENZIONE



519 M 612CLA

519 M 613BEA

519 M 613AEA

519 M 285KA

519 M 285A1

519 M 285A2

519 M 294B

519 M 324H

519 M 324STX

519 M 280HG

519 M 280N1

519 M 127C

519 M 150AX

519 M 382F

519 M 990A5MD

DESCRIZIONE	ART	PZ
Bussole esagonali, cricchetto (237 A), accessori 1/4 ed inserti	519 M 613AEA	46
Bussole esagonali, cricchetto (237 A) ed accessori 3/8	519 M 613BEA	20
Bussole esagonali lunghe e corte, cricchetto (237 A) ed accessori 1/2	519 M 612CLA	35
Chiavi combinate a cricchetto reversibili (8-9-10-12-13-14-15-16-17-18-19 mm)	519 M 285 KA	12
Chiavi combinate (6-7-8-9-10-12-13-14-15-16-17-18-19-22-24 mm)	519 M 285A1	17
Chiavi combinate (27-29-30-32-34 mm)	519 M 285A2	5
Chiave a rullino rapida e corta, pinza autobloccante e forbice	519 M 294B	4
Giraviti per viti ad intaglio ed a croce PHILLIPS	519 M 324H	7

DESCRIZIONE	ART	PZ
Giraviti per viti TORX	519 M 324STX	8
Chiavi maschio esagonali con impugnatura (3-4-5-6-7-8-10 mm)	519 M 280HG	7
Cassetta inserti assortita e chiavi maschio esagonali / TORX	519 M 280N1	117
Pinze per anelli elastici interni ed esterni 15÷25 e 19÷60	519 M 127C	6
Pinza universale, pinza regolabile, tronchese, pinza becchi lunghi e pinza grip	519 M 150AX	5
Lime a taglio mezzodolce	519 M 990A5B	5
Martello per meccanici, mazzuola, cacciaspine, scalpello e bulino	519 M 382F	7

Vuoi solo l'assortimento? Vai a pagina 40



CARRELLO 516 START RESISTENTE ED AFFIDABILE.



Piano di lavoro da 460 x 560 mm
con bordi anticaduta da 15 mm



Guide resistenti da 35 mm
con portata fino a 40 kg



Maniglie in ABS rinforzate
con apertura basculante



Risparmia il tuo tempo

Tutti i carrelli a cassetteria USAG sono subito pronti all'uso, perchè forniti con le ruote già montate alla struttura.



800 kg

5
CASSETTI

3
MODULI



516 ST5V
U05160105

RAL 3020

Carrello START (vuoto)

- Dimensioni interne:
 - 2 cassetti 570x420x60 mm.
 - 2 cassetti 570x420x130 mm.
 - 1 cassetto 570x420x270 mm.

~~709,00 €~~ **489,00 €**



800 kg

6
CASSETTI

3
MODULI



516 ST6V
U05160106

RAL 3020

Carrello START (vuoto)

516 ST6NV
U05160116

RAL 9005

Carrello START (vuoto)

- Dimensioni interne:
 - 3 cassetti 570x420x60 mm.
 - 2 cassetti 570x420x130 mm.
 - 1 cassetto 570x420x200 mm.

~~781,00 €~~ **539,00 €**



800 kg

7
CASSETTI

3
MODULI



516 ST7V
U05160107

RAL 3020

Carrello START (vuoto)

516 ST7NV
U05160117

RAL 9005

Carrello START (vuoto)

- Dimensioni interne:
 - 5 cassetti 570x420x60 mm.
 - 1 cassetto 570x420x130 mm.
 - 1 cassetto 570x420x200 mm.

~~853,00 €~~ **589,00 €**

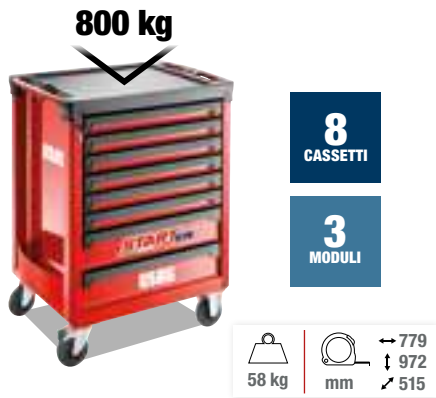

516 ST8V
U05160108

RAL 3020

Carrello START (vuoto)

- Dimensioni interne:
 - 6 cassetti 570x420x60 mm.
 - 2 cassetti 570x420x130 mm.

~~925,00 €~~ **639,00 €**



516 STXL6V
U05160146

RAL 3020

Carrello START (vuoto)

- Dimensioni interne:
 - 3 cassetti 760x420x60 mm.
 - 2 cassetti 760x420x130 mm.
 - 1 cassetto 760x420x200 mm.

~~945,00 €~~ **659,00 €**



516 STXL6NV
U05160156

RAL 9005

Carrello START (vuoto)

- Dimensioni interne:
 - 3 cassetti 760x420x60 mm.
 - 2 cassetti 760x420x130 mm.
 - 1 cassetto 760x420x200 mm.

~~945,00 €~~ **659,00 €**

Antiribaltamento



516 STS7V
U05160127

RAL 3020

Carrello START (vuoto)

516 STS7NV
U05160137

RAL 9005

Carrello START (vuoto)

- Dimensioni interne:
 - 5 cassetti 570x420x60 mm.
 - 1 cassetto 570x420x130 mm.
 - 1 cassetto 570x420x200 mm.

~~1.000,00 €~~ **699,00 €**



Novità

6 CASSETTI | 3 MODULI

72 kg | mm | 969 | 972 | 515

516 STB06V
U05160097

RAL 3020

Carrello START con cassetto verticale (vuoto)

- Dimensioni interne:
 - 3 cassetti 570x420x60 mm.
 - 2 cassetti 570x420x130 mm.
 - 1 cassetto 570x420x270 mm.

~~999,00 €~~ **699,00 €**



CASSETTO VERTICALE
sul lato destro con 3 ripiani di appoggio e serratura di chiusura indipendente.



NON TROVI IL TUO

Configuralo su



6
CASSETTI

3
MODULI

RISPARMI
200 €

Rispetto all'acquisto di carrello ed assortimento separati.



6
CASSETTI

3
MODULI

RISPARMI
200 €

Rispetto all'acquisto di carrello ed assortimento separati.

157
PEZZI

516 ST6PM
U05160630

RAL 3020



516 ST6NPM
U05161630

RAL 9005

Carrello START con assortimento MANUTENZIONE - 4 cassette

~~2.054,00 €~~

999,00 €

142
PEZZI

516 ST6PA
U05160629

RAL 3020



516 ST6NPA
U05161629

RAL 9005

Carrello START con assortimento AUTORIPARAZIONE - 2 cassette

~~2.030,00 €~~

999,00 €

ASSORTIMENTO MANUTENZIONE



519/613AEA 519/613CEA 519 SK692V

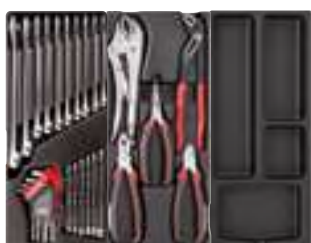

519/285A1 519/150AX 519 SK692V



519/324H 519/324TX 519 SK692V + 692 J32



519 SK692V 519/990A1 519/382F

ASSORTIMENTO AUTORIPARAZIONE



519/613AEA 519/613CEA 519 SK692V + 692 J32



519/324H 519/285A1 519/150AX



CHIAVI A T SNODATE
7-8-10-12-13-17 mm

DESCRIZIONE	ART	PZ
Bussole esagonali, cricchetto (237 A), accessori 1/4 ed inserti	519/613AEA	42
Bussole esagonali, cricchetto (237 A) ed accessori 1/2	519/613CEA	22
Chiavi combinate (6÷24 mm) + chiavi maschio esagonali (1,5÷10 mm)	519/285A1	25
Pinza universale, pinza regolabile, tronchese, pinza becchi lunghi e pinza grip	519/150AX	5
Giraviti per viti ad intaglio ed a croce PHILLIPS	519/324H	10
Giraviti per viti TORX	519/324TX	9
Lime a taglio mezzodolce	519/990A1	4
Martello per meccanici, mazzuola, cacciaspine, scalpello e bulino	519/382F	8
Assortimento di inserti con cricchetto reversibile	692 J32	32

DESCRIZIONE	ART	PZ
Bussole esagonali, cricchetto (237 A), accessori 1/4 ed inserti	519/613AEA	42
Bussole esagonali, cricchetto (237 A) ed accessori 1/2	519/613CEA	22
Giraviti per viti ad intaglio ed a croce PHILLIPS	519/324H	10
Chiavi combinate (6÷24 mm) + chiavi maschio esagonali (1,5÷10 mm)	519/285A1	25
Pinza universale, pinza regolabile, tronchese, pinza becchi lunghi e pinza grip	519/150AX	5
Chiavi a T snodate con bocca esagonale (7-8-10-12-13-17 mm)	276 CE	6
Assortimento di inserti con cricchetto reversibile	692 J32	32

Vuoi solo l'assortimento? Vai a pagina 41

ASSORTIMENTO IDEALE?

kitplanner.usag.it



6
CASSETTI

3
MODULI

RISPARMI
250 €

Rispetto all'acquisto di carrello ed assortimento separati.



6
CASSETTI

3
MODULI

RISPARMI
250 €

Rispetto all'acquisto di carrello ed assortimento separati.

156
PEZZI



516 ST6MM
U05160628

RAL 3020

516 ST6NMM
U05161628

RAL 9005

Carrello START con assortimento MANUTENZIONE - 4 cassette

~~2.385,00 €~~ **1.049,00 €**

155
PEZZI



516 ST6MA
U05160627

RAL 3020

516 ST6NMA
U05161627

RAL 9005

Carrello START con assortimento AUTORIPARAZIONE - 3 cassette

~~2.366,00 €~~ **1.049,00 €**

ASSORTIMENTO MANUTENZIONE



519 M 613AEA 519 M 613CEA 519 M 285A1



519 M 127C 519 M 150AX 519 MSK6



519 M 324H 519 M 324STX 519 MSK6+
692 J32



519 M 990A5B 519 M 382 519 MSK6

ASSORTIMENTO AUTORIPARAZIONE



519 M 285A1 519 M 324H 519 M 324STX

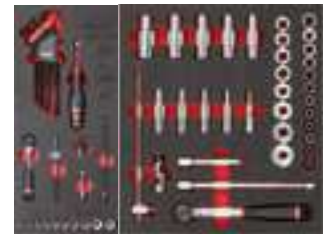

519 M 613AEA 519 M 612CLA

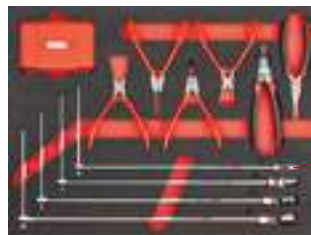

519 M 276C



CHIAVI A T SNODATE
8-10-13-17 mm

DESCRIZIONE	ART	PZ
Bussole esagonali, cricchetto (237 A), accessori 1/4 ed inserti	519 M 613AEA	46
Bussole esagonali, cricchetto (237 A) ed accessori 1/2	519 M 613CEA	23
Chiavi combinate (6-7-8-9-10-11-12-13-14-15-16-17-18-19-22-24 mm)	519 M 285A1	17
Pinze per anelli elastici interni ed esterni 15÷25 e 19÷60	519 M 127C	6
Pinza universale, pinza regolabile, tronchese, pinza becchi lunghi e pinza grip	519 M 150AX	5
Giraviti per viti ad intaglio ed a croce PHILLIPS	519 M 324H	7
Giraviti per viti TORX	519 M 324STX	8
Lime a taglio mezzodolce	519 M 990A5B	5
Martello per meccanici, mazzuola, cacciaspine, scalpello e bulino	519 M 382F	7
Assortimento di inserti con cricchetto reversibile	692 J32	32

DESCRIZIONE	ART	PZ
Bussole esagonali, cricchetto (237 A), accessori 1/4 ed inserti	519 M 613AEA	46
Bussole esagonali lunghe e corte, cricchetto (237 A) ed accessori 1/2	519 M 612CLA	35
Chiavi combinate (6-7-8-9-10-11-12-13-14-15-16-17-18-19-22-24 mm)	519 M 285A1	17
Giraviti per viti ad intaglio ed a croce PHILLIPS	519 M 324H	7
Giraviti per viti TORX	519 M 324STX	8
Pinze per anelli elastici, pinza universale, pinza becchi lunghi, chiavi snodate con bussola esagonale (8-10-13-17 mm), assortimento di inserti con cricchetto	519 M 276C	42

Vuoi solo l'assortimento? Vai a pagina 40



NON TROVI IL TUO ASSORTIMENTO IDEALE?

Configuralo su kitplanner.usag.it



6
CASSETTI

4
MODULI

RISPARMI 350 €

Rispetto all'acquisto di carrello ed assortimento separati.



6
CASSETTI

4
MODULI

RISPARMI 350 €

Rispetto all'acquisto di carrello ed assortimento separati.

301
PEZZI



516 STXL6MM
U05160632

RAL 3020

Carrello START con assortimento MANUTENZIONE - 4 cassette

~~3.741,00 €~~

1.799,00 €

301
PEZZI



516 STXL6NMM
U05161632

RAL 9005

Carrello START con assortimento MANUTENZIONE - 4 cassette

~~3.741,00 €~~

1.799,00 €

ASSORTIMENTO MANUTENZIONE



519 M 612CLA

519 M 613BEA

519 M 613AEA

519 M 285KA

519 M 285A1

519 M 285A2

519 M 294B

519 M 324H

519 M 324STX

519 M 280HG

519 M 280N1

519 M 127C

519 M 150AX

519 M 382F

519 M 990A5MD

DESCRIZIONE	ART	PZ
Bussole esagonali, cricchetto (237 A), accessori 1/4 ed inserti	519 M 613AEA	46
Bussole esagonali, cricchetto (237 A) ed accessori 3/8	519 M 613BEA	20
Bussole esagonali lunghe e corte, cricchetto (237 A) ed accessori 1/2	519 M 612CLA	35
Chiavi combinate a cricchetto reversibili (8-9-10-11-12-13-14-15-16-17-18-19 mm)	519 M 285 KA	12
Chiavi combinate (6-7-8-9-10-11-12-13-14-15-16-17-18-19-22-24 mm)	519 M 285A1	17
Chiavi combinate (27-29-30-32-34 mm)	519 M 285A2	5
Chiave a rullino rapida e corta, pinza autobloccante e forbice	519 M 294B	4
Giraviti per viti ad intaglio ed a croce PHILLIPS	519 M 324H	7

DESCRIZIONE	ART	PZ
Giraviti per viti TORX	519 M 324STX	8
Chiavi maschio esagonali con impugnatura (3-4-5-6-7-8-10 mm)	519 M 280HG	7
Cassetta inserti assortita e chiavi maschio esagonali / TORX	519 M 280N1	117
Pinze per anelli elastici interni ed esterni 15÷25 e 19÷60	519 M 127C	6
Pinza universale, pinza regolabile, tronchese, pinza becchi lunghi e pinza grip	519 M 150AX	5
Lime a taglio mezzodolce	519 M 990A5B	5
Martello per meccanici, mazzuola, cacciaspine, scalpello e bulino	519 M 382F	7

Vuoi solo l'assortimento? Vai a pagina 40

LA TUA NUOVA POSTAZIONE DA LAVORO MOBILE

Novità

12
CASSETTI

3
MODULI



Piano sporgente per utilizzo con morsetti.

1.200 kg



516 STBU12V
U05160098

RAL 9005

200 kg
mm
↔ 1.563
↓ 1.077
↙ 800

Banco da lavoro mobile START (vuoto)

- Piano di lavoro in legno multistrato spessore 30 mm.
- Dimensioni piano di lavoro 1.350x800 mm.
- Possibilità di montare una morsa da banco o utilizzare dei morsetti a barra sulle sporgenze laterali del piano di lavoro.
- Doppia maniglia di trasporto in tubolare d'acciaio.
- Cassetti ad estrazione totale montati su guide telescopiche a sfera.
- Tappetini interni in gomma antiolio.
- Ruote in gomma antiolio (Ø 160 mm): due fisse e quattro pivotanti con freno.
- Fornito con 4 porta flaconi posizionabili sui lati delle cassetiere.
- Pannelli laterali e pannello posteriore predisposti per il montaggio di accessori opzionali.
- Armadio portaoggetti con anta richiudibile con serratura e 3 ripiani di appoggio interni (dimensioni interne 310x310x74 mm).
- Due cassetti laterali con serratura indipendente (dimensioni interne 285x335x300 mm).
- Fornito con ruote già assemblate alla struttura.
- Portata massima cassetti: 40 kg.
- Dimensioni interne cassetti:
 - 3 cassetti 570x420x60 mm;
 - 2 cassetti 570x420x130 mm;
 - 1 cassetto 570x420x270 mm.

2.356,00 €

1.649,00 €

OPERATIVITÀ A TUTTO TONDO

Un banco, quattro lati,
Infinite possibilità:
lavora ovunque, da
qualsiasi angolazione!

MUOVITI SENZA LIMITI

Grazie alle sue 6 ruote, di
cui 4 pivotanti, il banco
ruota a 360° offrendo
la massima versatilità di
movimento anche negli
spazi più stretti.



360°

**Arredamento
da officina**

START516



YouTube

LINEA ARREDAMENTO START 516

LA TUA POSTAZIONE DI LAVORO PROFESSIONALE.



LA QUALITÀ DEI NOSTRI CARRELLI 516



Guide telescopiche da 35 mm
con portata fino a 40Kg.
Maniglie in ABS rinforzate.

PIANO DI LAVORO IN ACCIAIO O IN LEGNO AMPIO E RESISTENTE



Profondità utile: 600 mm.
Portata statica massima: 1000 Kg.

COMPATIBILE CON LA GAMMA MODULI



Puoi assortire carrello e cassettiere
utilizzando la gamma di moduli in
spugna ed in plastica.

**VUOI CREARE
LA TUA POSTAZIONE SU MISURA?**
Configurala su start516.usag.it





Assortimento 301 utensili incluso



DESCRIZIONE	ART	PZ
Mobile fisso con 6 cassetti	516 SA/1T	1
Mobile fisso con 2 ante	516 SA/2T	1
Pannelli forati portautensili	516 SA5T	6
Pensili con anta basculante	516 SA/4T	3
Armadio a 1 anta	516 SA/3T	1
Carrello START - 6 cassetti (vuoto)	516 SA/16T	1
Kit di montaggio	516 SA14T	3
Rialzi per mobili	516 SA11T	3



516 SA/STBP RAL 9005
U05160318



Pianali in acciaio
2.175 mm - 516 AC/2

Arredamento per officina con assortimento

~~7.842,00 €~~ **4.599,00 €**

Ganci e lampade non inclusi



DESCRIZIONE	ART	PZ
Mobile fisso con 6 cassetti	516 SA/1T	1
Mobile fisso con 2 ante	516 SA/2T	1
Pannelli forati portautensili	516 SA5T	6
Pensili con anta basculante	516 SA/4T	3
Armadio a 1 anta	516 SA/3T	1
Carrello START - 6 cassetti (vuoto)	516 SA/16T	1
Kit di montaggio	516 SA14T	3
Rialzi per mobili	516 SA11T	3

Ganci e lampade non inclusi



516 SA/STAP RAL 9005
U05160318



Pianali in acciaio
2.175 mm - 516 AC/2

Arredamento per officina - pianale in acciaio

~~5.046,00 €~~ **3.533,00 €**



516 SA/STLP RAL 9005
U05160314



Pianali in legno
2.175 mm - 516 SAL/2

Arredamento per officina - pianale in legno

~~5.046,00 €~~ **3.533,00 €**



VUOI CREARE LA TUA Configurala su



Configurazione completa

INCLUDE: GANCI, LAMPADE LED, PRESA MULTIPLA E CASSETTI SU RUOTE

DESCRIZIONE	ART	PZ
Mobile fisso con 7 cassetti	516 SA1T/7	1
Mobile base con portarifiuti e portarotolo	516 SA17T	1
Pannelli forati portautensili	516 SA5T	5
Pannello forato portautensili con 3 prese SCHUKO e 2 porte USB	516 SA6T	1
Pensili con anta basculante	516 SA/4T	3
Armadio a 2 ante	516 SA3T/2	1
Carrello START - 6 cassetti (vuoto)	516 SA/16T	1
Supporto per avvitatori	516 SA4TP	1
Cassetti su ruote per mobili base	516 SA20T	2
Lampade a LED	516 SA/12	2
Kit di montaggio	516 SA14T	3
Rialzi per mobili	516 SA11T	3



516 SA/PRA
U05160295

RAL 9005

342 kg 3.175 mm 2.000 mm 650

Pianali in acciaio
2.175 mm - 516 AC/2

Arredamento per officina - pianale in acciaio
• Fornita con kit base di 30 ganci 516 SA/K1.

~~6.280,00 €~~ **4.396,00 €**



516 SA/PRL
U05160296

RAL 9005

332 kg 3.175 mm 2.000 mm 650

Pianali in legno
2.175 mm - 516 SAL/2

Arredamento per officina - pianale in legno
• Fornita con kit base di 30 ganci 516 SA/K1.

~~6.280,00 €~~ **4.396,00 €**



Configurazione completa

INCLUDE: GANCI, LAMPADE LED, PRESA MULTIPLA E CASSETTI SU RUOTE

DESCRIZIONE	ART	PZ
Mobile fisso con 6 cassetti	516 SA/1T	1
Mobile fisso con 2 ante	516 SA/2T	1
Pannelli forati portautensili	516 SA5T	3
Pannello forato portautensili con 3 prese SCHUKO e 2 porte USB	516 SA6T	1
Pensili con anta basculante	516 SA/4T	2
Armadio a 1 anta	516 SA/3T	1
Cassetti su ruote per mobili base	516 SA20T	2
Kit di montaggio	516 SA14T	2
Rialzi per mobili	516 SA11T	3



516 SA/CA
U05160291

RAL 9005

205 kg 1.950 mm 2.000 mm 650

Pianali in acciaio
1.450 mm - 516 AC/1

Arredamento per officina - pianale in acciaio
• Fornita con kit base di 30 ganci 516 SA/K1.

~~4.348,00 €~~ **3.044,00 €**



516 SA/CL
U05160292

RAL 9005

197 kg 1.950 mm 2.000 mm 650

Pianali in legno
1.450 mm - 516 SAL/1

Arredamento per officina - pianale in legno
• Fornita con kit base di 30 ganci 516 SA/K1.

~~4.348,00 €~~ **3.044,00 €**

POSTAZIONE SU MISURA?

start516.usag.it



DESCRIZIONE	ART	PZ
Mobile fisso con 6 cassetti	516 SA/1T	1
Mobile fisso con 2 ante	516 SA/2T	1
Carrello START - 6 cassetti (vuoto)	516 SA/16T	1
Rialzi per mobili	516 SA11T	2



516 SA/BCA
U05160289



Banco da lavoro - pianale in acciaio

Pianali in acciaio
2.175 mm - 516 AC/2

~~2.591,00 €~~ **1.814,00 €**



516 SA/BCL
U05160290



Banco da lavoro - pianale in legno

Pianali in legno
2.175 mm - 516 SAL/2

~~2.591,00 €~~ **1.814,00 €**



DESCRIZIONE	ART	PZ
Mobile con 6 cassetti	516 SA1T/6	1
Coppia di rialzi	516 SA11T	2
Montante per linea arredamento	516 SAM	1



516 SA/BC2A
U05160322



Banco da lavoro - pianale in acciaio

Pianali in acciaio
2.175 mm - 516 AC/2

~~1.446,00 €~~ **1.013,00 €**



516 SA/BC2L
U05160323



Banco da lavoro - pianale in legno

Pianali in legno
2.175 mm - 516 SAL/2

~~1.446,00 €~~ **1.013,00 €**



516 SA/BC1A
U05160324



Banco da lavoro - pianale in acciaio

Pianali in acciaio
1.450 mm - 516 AC/1

~~1.368,00 €~~ **958,00 €**



516 SA/BC1L
U05160325



Banco da lavoro - pianale in legno

Pianali in legno
1.450 mm - 516 SAL/1

~~1.368,00 €~~ **958,00 €**



SISTEMA BANCHI 506 RESISTENZA E STABILITÀ AL TOP.

YouTube



ACCESSORI LATERALI
compatibile con la linea 516
(solo modelli 506 KA e KL).



CASSETTI MAGGIORATI
montati su guide ad alte prestazioni.

2.000 kg



2000-mm



2.000 kg



2000-mm



506 KA
U05060256



Postazione di lavoro con piano in acciaio

- Piano di lavoro in lamiera d'acciaio zincata spessore 3 mm con bordi anticaduta da 37 mm.
- Struttura resistente a 6 montanti.
- Doppio cassetto ad estrazione totale con serratura.
- Ante in lamiera d'acciaio con cerniere regolabili.
- Ripiano interno in dotazione.
- Pannelli laterali con agganci per accessori linea 516.
- Predisposizione per il fissaggio a pavimento.
- Portata statica: 2000 Kg.
- Dimensioni interne cassette: 830x550x110 mm.
- Dimensioni interne vano con ante: 860x350x440 mm
- Verniciato colore nero RAL 9005
- Consegnato smontato.

1.666,00 €

1.166,00 €

506 KL
U05060246



Postazione di lavoro con piano in legno

- Piano di lavoro in legno multistrato spessore 30 mm.
- Struttura resistente a 6 montanti.
- Doppio cassetto ad estrazione totale con serratura.
- Ante in lamiera d'acciaio con cerniere regolabili.
- Ripiano interno in dotazione.
- Pannelli laterali con agganci per accessori linea 516.
- Predisposizione per il fissaggio a pavimento.
- Portata statica: 2000 Kg.
- Dimensioni interne cassette: 830x550x110 mm.
- Dimensioni interne vano con ante: 860x350x440 mm
- Verniciato colore nero RAL 9005
- Consegnato smontato.

1.835,00 €

1.285,00 €

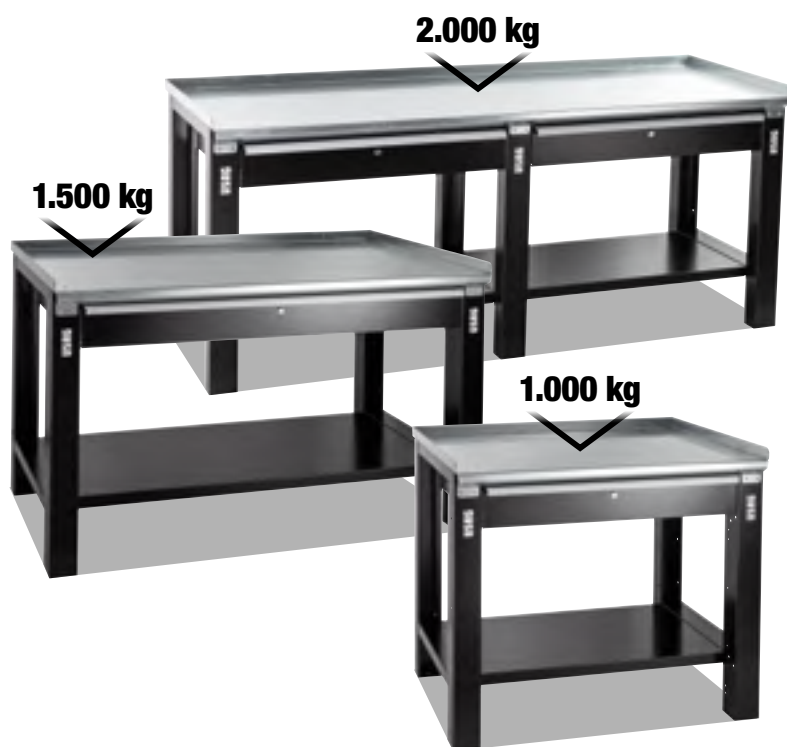

506 TAC

RAL 9005

ACCIAIO

Banchi da lavoro con piano in acciaio

- Piano di lavoro in lamiera d'acciaio zincata spessore 3 mm con bordi anticaduta da 37 mm.
- Montanti e ripiano inferiore in lamiera d'acciaio spessore 1,2 mm.
- Fori laterali per il fissaggio di più banchi affiancati.
- Predisposizione per il fissaggio a pavimento.
- 6 montanti per il modello di lunghezza 2 metri.
- Spazio tra due montanti: 864 mm.
- Spazio tra il ripiano di appoggio ed il piano di lavoro: 525 mm.
- Dimensioni interne cassetti:
 - L 1000 e L 2000: 830x550x110 mm
 - L 1500: 1280x550x110 mm
- Consegnato smontato.

CODICE	DIMENSIONI LxPxH	PESO	N° cassetti		
U05060154	1046x700x910 mm	65 kg	1	578,00 €	405,00 €
U05060155	1500x700x910 mm	85 kg	1	717,00 €	502,00 €
U05060156	2000x700x910 mm	110 kg	2	975,00 €	683,00 €



506 TLC

RAL 9005

LEGNO



Banchi da lavoro con piano in legno

- Piano di lavoro in legno multistrato spessore 30 mm.
- Montanti e ripiano inferiore in lamiera d'acciaio spessore 1,2 mm.
- Fori laterali per il fissaggio di più banchi affiancati.
- Predisposizione per il fissaggio a pavimento.
- 6 montanti per il modello di lunghezza 2 metri.
- Spazio tra due montanti: 864 mm.
- Spazio tra il ripiano di appoggio ed il piano di lavoro: 525 mm.
- Dimensioni interne cassetti:
 - L 1000 e L 2000: 830x550x110 mm
 - L 1500: 1280x550x110 mm
- Consegnato smontato.

CODICE	DIMENSIONI LxPxH	PESO	N° cassetti		
U05060144	1046x700x910 mm	55 kg	1	685,00 €	480,00 €
U05060145	1500x700x910 mm	75 kg	1	854,00 €	598,00 €
U05060146	2000x700x910 mm	100 kg	2	1.144,00 €	801,00 €



506 KD

Kit divisori per cassetti 506 TC

- Compatibilità:
 - 506 KD1: per cassetto 506 TC1;
 - 506 KD2: per cassetto 506 TC2.

CODICE	MIS	PESO		
U05060156Q	1	3 kg	146,00 €	102,00 €
U05060157Q	2	5 kg	182,00 €	127,00 €

Banchi da lavoro

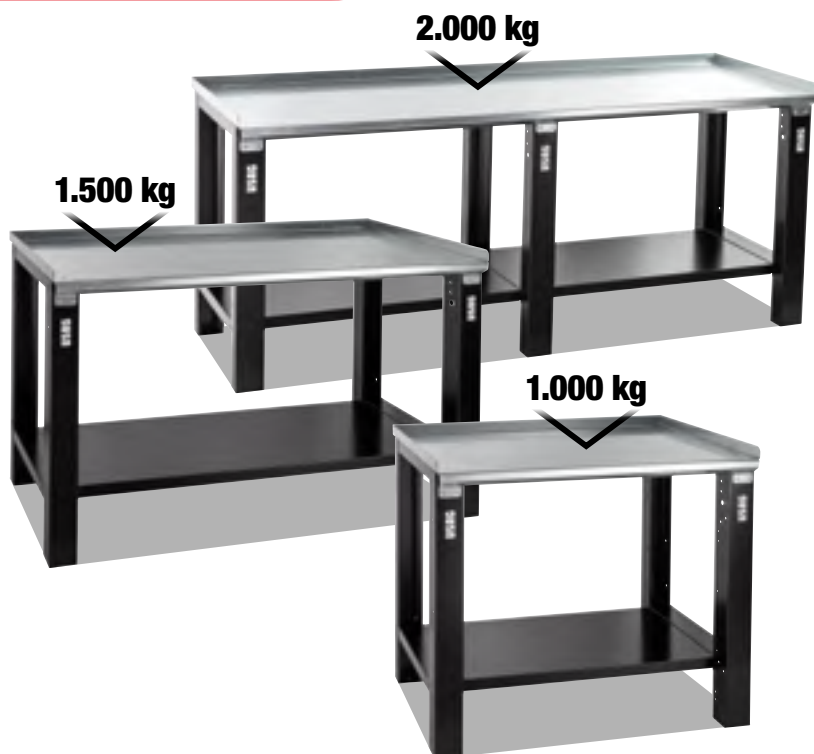

506 TA

RAL 9005

ACCIAIO

Banchi da lavoro con piano in acciaio

- Piano di lavoro in lamiera d'acciaio zincata spessore 3 mm con bordi anticaduta da 37 mm.
- Montanti e ripiano inferiore in lamiera d'acciaio spessore 1,2 mm.
- Fori laterali per il fissaggio di più banchi affiancati.
- Predisposizione per il fissaggio a pavimento.
- 6 montanti per il modello di lunghezza 2 metri.
- Spazio tra due montanti: 864 mm.
- Spazio tra il ripiano di appoggio ed il piano di lavoro: 660 mm.
- Consegnato smontato.

CODICE	DIMENSIONI LxPxH	PESO		
U05060054	1046x700x910 mm	50 kg	381,00 €	267,00 €
U05060055	1500x700x910 mm	60 kg	458,00 €	321,00 €
U05060056	2000x700x910 mm	80 kg	581,00 €	407,00 €

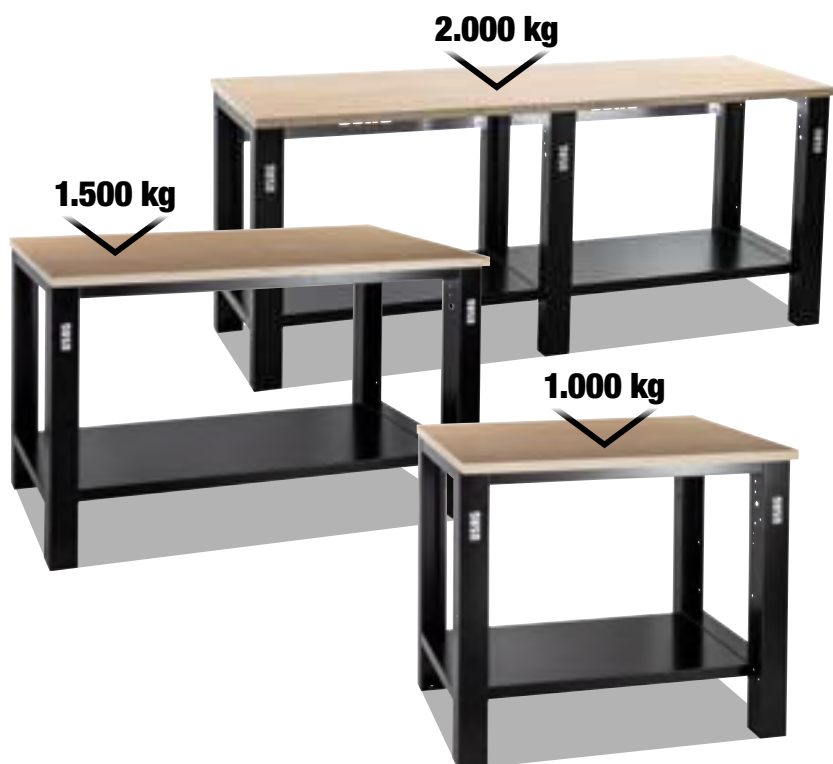

506 TL

RAL 9005



LEGNO

Banchi da lavoro con piano in legno

- Piano di lavoro in legno multistrato spessore 30 mm.
- Montanti e ripiano inferiore in lamiera d'acciaio spessore 1,2 mm.
- Fori laterali per il fissaggio di più banchi affiancati.
- Predisposizione per il fissaggio a pavimento.
- 6 montanti per il modello di lunghezza 2 metri.
- Spazio tra due montanti: 864 mm.
- Spazio tra il ripiano di appoggio ed il piano di lavoro: 660 mm.
- Consegnato smontato.

CODICE	DIMENSIONI LxPxH	PESO		
U05060044	1046x700x910 mm	40 kg	488,00 €	342,00 €
U05060045	1500x700x910 mm	50 kg	595,00 €	417,00 €
U05060046	2000x700x910 mm	70 kg	750,00 €	525,00 €



506 TC

RAL 9005

Cassetti per banchi da lavoro

- Compatibili con banchi 506 TA e 506 TL.
- Guide telescopiche con resistenza al carico fino a 60 Kg.

CODICE	MIS	DIMENSIONI INT. LxPxH	PESO		
U05060154Q	1	830x550x110 mm	15 kg	197,00 €	138,00 €
U05060155Q	2	1280x550x110 mm	25 kg	259,00 €	181,00 €

Novità

2.000 kg

1
CASSETTO

3
RIPIANI



506 TAS
U05060257



ACCIAIO

Banco da lavoro con piano in acciaio e carrello multiuso a 3 ripiani

1.041,00 €

683,00 €

Novità

2.000 kg

1
CASSETTO

3
RIPIANI



506 TLS
U05060247



LEGNO



Banco da lavoro con piano in legno e carrello multiuso a 3 ripiani

1.210,00 €

801,00 €

200 kg



COMPATIBILITÀ CON I BANCHI 506 TA E TL

2 coppie ruote per modelli da 1000 e 1500,
3 coppie ruote per modelli da 2000.



CARRELLO SOTTOBANCO



3
RIPIANI

516 SN
U05160265

RAL 9005

Carrello multiuso a 3 ripiani

- 3 ripiani da 500x700 mm.
- Ripiani coperti da tappetini in ABS da 2 mm.
- Bordi anticaduta da 37 mm su tutti e 3 i ripiani.
- Doppia maniglia frontale in ABS.
- Quattro ruote pivotanti (Ø 100 mm) di cui due con freno.
- Fornito smontato.
- Portata massima: 200 Kg.
- Struttura verniciata colore nero RAL 9005.

263,00 €

184,00 €

Novità



506 TP
U05060159Q

RAL 9005

Coppia montanti per pannello forato

- Permettono di fissare i pannelli 501 P ai banchi da lavoro 506 TA, 506 TL e 506 K.
- Compatibili con tutti i modelli di banco da lavoro 506, sia con piano in acciaio che con piano in legno.
- Adatte a tutte le dimensioni di banco: 1000, 1500, 2000.

130,00 €

91,00 €

506 TR
U05060158Q

Kit ruote per banchi da lavoro

- Kit composto da due ruote pivotanti Ø100 mm.
- Banchi da 1000 e 1500: portata statica massima con ruote 500 Kg.
- Banchi da 2000: portata statica massima con ruote 900 Kg.
- Supporti ruote in lamiera d'acciaio zincata.

179,00 €

79,00 €

Altri carrelli



504 SR U05040004

RAL 3020

Carrello multiuso

- 3 ripiani da 770x448 mm.
- Ripiani coperti da tappetini in ABS da 2 mm.
- Bordi anticaduta da 37 mm su tutti e 3 i ripiani.
- Maniglia in tubolare d'acciaio diametro 25 mm.
- Fianchi predisposti per gli accessori laterali 516.
- Due ruote pivotanti e due ruote fisse (Ø 100 mm) di cui una con freno.
- Fornito smontato.

~~235,00 €~~

163,00 €



504 SN U05040014

RAL 9005

Carrello multiuso

- 3 ripiani da 770x448 mm.
- Ripiani coperti da tappetini in ABS da 2 mm.
- Bordi anticaduta da 37 mm su tutti e 3 i ripiani.
- Maniglia in tubolare d'acciaio diametro 25 mm.
- Fianchi predisposti per gli accessori laterali 516.
- Due ruote pivotanti e due ruote fisse (Ø 100 mm) di cui una con freno.
- Fornito smontato.

~~235,00 €~~

163,00 €



504 SNA U05040015

RAL 9005

Carrello multiuso con cassetto

- 3 ripiani da 770x448 mm.
- Ripiani coperti da tappetini in ABS da 2 mm.
- Bordi anticaduta da 37 mm su tutti e 3 i ripiani.
- Maniglia in tubolare d'acciaio diametro 25 mm.
- Fianchi predisposti per gli accessori laterali 516.
- Due ruote pivotanti e due ruote fisse (Ø 100 mm) di cui una con freno.
- Cassetto con guide telescopiche da 20 Kg.
- Doppie chiavi in dotazione.
- Dimensioni interne cassetto: 570x420x60 mm.
- Fornito smontato.

~~359,00 €~~

251,00 €

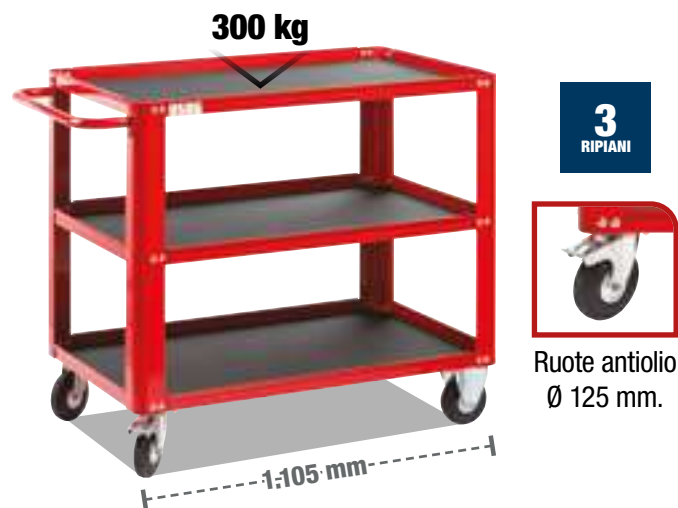

504 SRXL U05040005

RAL 3020

Carrello multiuso di grandi dimensioni

- Ripiani coperti da tappetini in ABS da 2 mm.
- Bordi anticaduta da 37 mm su tutti e 3 i ripiani.
- Maniglia tubolare d'acciaio diametro 25 mm.
- Due ruote pivotanti e due ruote fisse (Ø 125 mm) di cui una con freno.
- Fornito smontato.
- Portata massima: 300 Kg.
- Struttura verniciata colore rosso RAL 3020.

~~419,00 €~~

293,00 €



503 T U05030002

25 kg

Carrello multiuso con maniglia pieghevole

- Pianale di carico in lamiera zincata con barre di rinforzo sotto al piano.
- Maniglia ampia in tubolare d'acciaio e richiudibile sul pianale per il trasporto con il minimo ingombro.
- Quattro ruote in gomma Ø 125 mm, due fisse e due pivotanti di cui una con freno.
- Dimensioni utili pianale di carico: 760x560 mm.
- Altezza piano di carico da terra: 158 mm.

~~224,00 €~~

157,00 €

ACCESSORI PER CARRELLI E CASSETTIERE

Novità



516 AT1
U05160401

Porta rotolo per carrelli e cassettiere

- Accessorio laterale per carrelli RACING 519, START 516 e JUST 515.
- Adatto anche ai mobili base della linea arredamento.
- START 516 ed ai fianchi dei banchi da lavoro 506 K.

~~58,00 €~~ **39,00 €**

Novità



516 AT2
U05160402

Porta flaconi per carrelli e cassettiere

- Accessorio laterale per carrelli RACING 519, START 516 e JUST 515.
- Adatto anche ai mobili base della linea arredamento.
- START 516 ed ai fianchi dei banchi da lavoro 506 K.

~~58,00 €~~ **39,00 €**

100 kg



72
Litri

87
Litri

103
Litri

532 T

RAL
3020

Bauli portautensili professionali

- Design laterale studiato per aumentare la rigidità della struttura.
- Cerniere coperchio in acciaio zincato con punto di arresto in apertura a 105°.
- Struttura in lamiera d'acciaio verniciata rosso RAL 3020.

CODICE	L (mm)	P (mm)	H (mm)		Prezzo	Prezzo
B U05320016	700	350	350	14 kg	195,00 €	137,00 €
C U05320017	850	350	350	16 kg	210,00 €	147,00 €
D U05320018	1000	350	350	18 kg	240,00 €	168,00 €



Maniglie di trasporto molto ampie, integrate nei fianchi laterali.

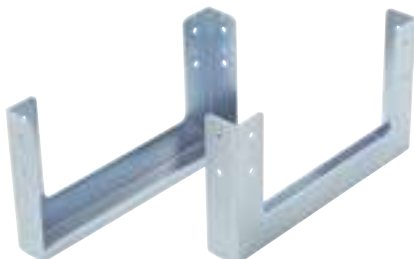

532 TK
U05320001Q

Coppia rialzi per bauli portautensili

- Compatibili con i bauli portautensili 532 T.
- Lamiera d'acciaio zincata spessore 3 mm.

~~105,00 €~~ **73,50 €**



STUDIATI PER DARE LA POSSIBILITÀ DI TRASPORTARE IL BAULE CON UN CARRELLO ELEVATORE O TRANSPALLET.

Contenitori trasportabili

MAX
20 kg

4,7 kg | mm | 465
352
215



001 RV
U00010004

Valigia porta utensili in polipropilene ad alto spessore (vuota)

- Due pannelli interni amovibili con elastici portautensili.
- Vano inferiore con divisori amovibili e regolabili.
- Doppia serratura con chiave.

~~308,00 €~~

216,00 €

MAX
20 kg

6 kg | mm | 465
352
255



001 TRV
U00010005

Valigia trolley porta utensili in polipropilene ad alto spessore (vuota)

- Maniglia telescopica in alluminio.
- Ruote con cuscinetto a sfera integrato.

~~453,00 €~~

317,00 €



5
SCOMPARTI

6,6 kg | mm | 560
320
220



646/5LV
U06460301

Cassetta estensibile LUNGA (vuota)

- Predisposizione per lucchetto.
- Struttura in lamiera d'acciaio con verniciatura anaforetica.

~~88,00 €~~

61,50 €

8
VASCHETTE

1,5 kg | mm | 422
106
335



640 A
U06400001

Organizer (vuoto)

- Coperchio trasparente: visibilità istantanea del contenuto.
- 8 vaschette interne amovibili di cui 1 suddivisibile tramite 2 divisori in dotazione.

~~33,60 €~~

23,50 €

641 T

Cassetta portautensili (vuota)

- In materiale plastico ad alta resistenza.
- 2 scomparti portaminuteria sul coperchio.
- Possibilità di chiusura con lucchetto (non fornito).
- Vassoio interno amovibile.

	CODICE	L (mm)	P (mm)	H (mm)	kg	
A	U06410004	16"	394	220	1,2 kg	24,80 € 17,40 €
B	U06410005	19"	486	266	2,1 kg	37,20 € 26,00 €
C	U06410006	24"	595	281	2,8 kg	49,50 € 34,60 €





▶ YouTube



5,4 kg	mm	↔ 550 ↑ 440 ↙ 360	MAX 18 kg	CAPACITÀ 33 L
--------	----	-------------------------	---------------------	-------------------------

007 TXV U00070065

Borsa trolley portautensili (vuota)

- Tessuto ad altissima resistenza (Poliesteri 1200D&600D).
- Maniglia telescopica.
- Ruote con diametro 90 mm.
- 6 tasche esterne e 1 tasca frontale porta seghetto.
- Vani interni portautensili.
- Maniglione in alluminio con impugnatura rivestita.
- Mantella di chiusura con velcro.

~~170,00 €~~ **99,00 €**



4 kg	mm	↔ 490 ↑ 350 ↙ 220	MAX 15 kg	CAPACITÀ 47 L
------	----	-------------------------	---------------------	-------------------------

007 V U00070002

Borsa portautensili (vuota)

- Tessuto ad altissima resistenza (Poliesteri 1200D&600D).
- Base rigida resistente all'acqua.
- Vani interni portautensili e tasca frontale porta seghetto.
- Maniglione in alluminio con impugnatura rivestita.
- Cinghia di trasporto a tracolla.
- Mantella di chiusura con velcro.

~~107,00 €~~ **75,00 €**



2,5 kg	mm	↔ 420 ↑ 340 ↙ 240	MAX 11 kg	CAPACITÀ 34 L
--------	----	-------------------------	---------------------	-------------------------

007/1V U00070001

Borsa portautensili (vuota)

- Tessuto ad altissima resistenza (Poliesteri 1200D&600D).
- Base rigida e resistente all'acqua.
- Pratici e comodi vani interni portautensili.
- Due tasche frontali portaminuteria.
- Pratico maniglione in alluminio.
- Ganci interni porta flessometro ed elastici portautensili.
- Mantella di chiusura tramite velcro.

~~82,50 €~~ **57,50 €**



3,1 kg	mm	↔ 355 ↑ 225 ↙ 460	MAX 12 kg	CAPACITÀ 30 L
--------	----	-------------------------	---------------------	-------------------------

MAX 12 kg	CAPACITÀ 30 L
---------------------	-------------------------

007 SV U00070004

Zaino portautensili (vuoto)

- Tessuto ad altissima resistenza (Poliesteri 1200D&600D).
- Cinturino pettorale regolabile.
- Cinghie in vita imbottite.
- Base rigida resistente all'acqua.
- Vano interno portautensili.
- Portadocumenti interno.
- La tasca posteriore può contenere Notebook di dimensioni: L 340 mm - H 240 mm.

~~100,00 €~~ **70,00 €**



1 kg	mm	↔ 360 ↑ 280 ↙ 190	MAX 10 kg	CAPACITÀ 15 L
------	----	-------------------------	---------------------	-------------------------

MAX 10 kg	CAPACITÀ 15 L
---------------------	-------------------------

007 MCV U00070008

Borsa portautensili (vuota)

- Tessuto ad altissima resistenza (Poliesteri 600D).
- Base rigida resistente all'acqua.
- Vani interni portautensili.
- 3 tasche frontali con mantella di protezione.
- 3 tasche posteriori.
- Maniglie con rivestimento in PVC.
- Cinghia di trasporto a tracolla.

~~58,50 €~~ **40,90 €**



470 g	mm	↔ 310 ↑ 220 ↙ 140	MAX 9 kg	CAPACITÀ 8 L
-------	----	-------------------------	--------------------	------------------------

MAX 9 kg	CAPACITÀ 8 L
--------------------	------------------------

007 FLV U00070007

Borsa portautensili (vuota)

- Tessuto ad altissima resistenza (Poliesteri 600D).
- Tasca frontale con chiusura a cerniera.
- Tasca posteriore con chiusura a velcro.
- Base rigida rinforzata.
- Vani interni portautensili.
- Maniglie con rivestimento in PVC.

~~29,90 €~~ **20,50 €**

MODULI IN SPUGNA BICOLORE



519 M 613AEA 519 M 613CEA 519 M 285A1



519 M 127C 519 M 150AX 519 MSK6



519 M 324H 519 M 324STX 519 MSK6+692 J32



519 M 990A5B 519 M 382 519 MSK6

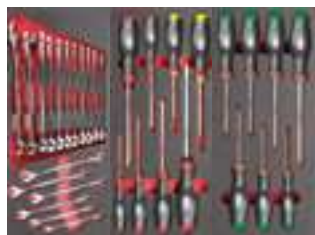

519 M 285A1 519 M 324H 519 M 324STX

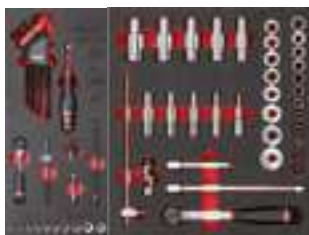

519 M 613AEA 519 M 612CLA

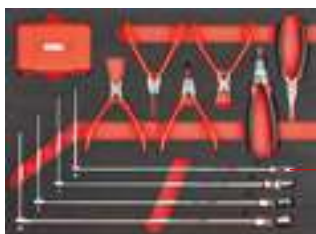

519 M 276C



CHIAVI A T SNODATE
8-10-13-17 mm

495 MB
U04950628

156
PEZZI



Assortimento MANUTENZIONE - 4 cassetti

DESCRIZIONE	ART	PZ
Bussole esagonali, cricchetto (237 A), accessori 1/4 ed inserti	519 M 613AEA	46
Bussole esagonali, cricchetto (237 A) ed accessori 1/2	519 M 613CEA	23
Chiavi combinate (6-7-8-9-10-11-12-13-14-15-16-17-18-19-22-24 mm)	519 M 285A1	17
Pinze per anelli elastici interni ed esterni 15÷25 e 19÷60	519 M 127C	6
Pinza universale, pinza regolabile, tronchese, pinza becchi lunghi e pinza grip	519 M 150AX	5
Giraviti per viti ad intaglio ed a croce PHILLIPS	519 M 324H	7
Giraviti per viti TORX	519 M 324STX	8
Lime a taglio mezzodolce	519 M 990A5B	5
Martello per meccanici, mazzuola, cacciapine, scalpello e bulino	519 M 382F	7
Assortimento di inserti con cricchetto reversibile	692 J32	32

~~1.604,00 €~~

760,00 €

495 MAA
U04950627

155
PEZZI



Assortimento AUTORIPARAZIONE - 3 cassetti

DESCRIZIONE	ART	PZ
Bussole esagonali, cricchetto (237 A), accessori 1/4 ed inserti	519 M 613AEA	46
Bussole esagonali lunghe e corte, cricchetto (237 A) ed accessori 1/2	519 M 612CLA	35
Chiavi combinate (6-7-8-9-10-11-12-13-14-15-16-17-18-19-22-24 mm)	519 M 285A1	17
Giraviti per viti ad intaglio ed a croce PHILLIPS	519 M 324H	7
Giraviti per viti TORX	519 M 324STX	8
Pinze per anelli elastici, pinza universale, pinza becchi lunghi, chiavi snodate con bussola esagonale (8-10-13-17 mm), assortimento di inserti con cricchetto	519 M 276C	42

~~1.585,00 €~~

760,00 €

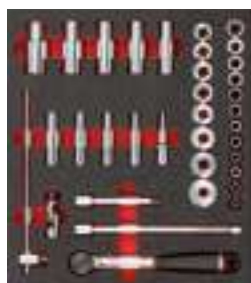

519 M 612CLA



519 M 613BEA 519 M 613AEA



519 M 285KA 519 M 285A1 519 M 285A2 519 M 294B

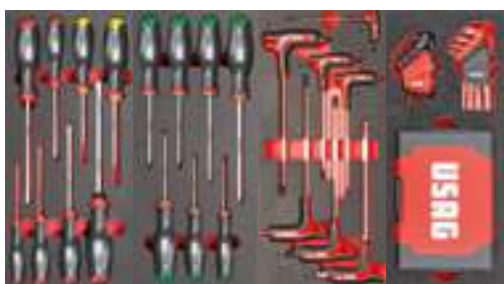

519 M 324H 519 M 324STX 519 M 280HG 519 M 280N1



519 M 127C 519 M 150AX 519 M 382F 519 M 990A5MD

301
PEZZI



495 MC
U04950632

Assortimento MANUTENZIONE
4 cassetti

~~2.796,00 €~~

1.490,00 €

MODULI IN PLASTICA



519/613AEA 519/613CEA 519 SK692V

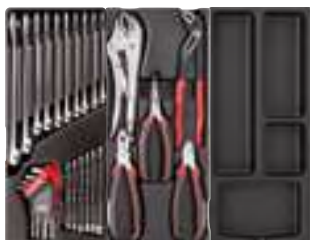

519/285A1 519/150AX 519 SK692V



519/324H 519/324TX 519 SK692V + 692 J32



519 SK692V 519/990A1 519/382F



519/613AEA 519/613CEA 519 SK692V + 692 J32



519/324H 519/285A1 519/150AX

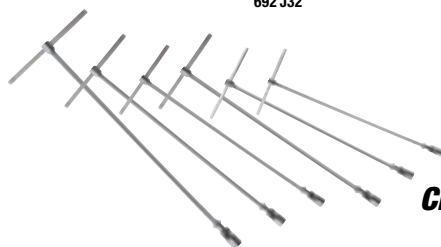

CHIAVI A T SNODATE
7-8-10-12-13-17 mm

495 PM
U04950630

157
PEZZI



Assortimento MANUTENZIONE - 4 cassette

DESCRIZIONE	ART	PZ
Bussole esagonali, cricchetto (237 A), accessori 1/4 ed inserti	519/613AEA	42
Bussole esagonali, cricchetto (237 A) ed accessori 1/2	519/613CEA	22
Chiavi combinate (6÷24 mm) + chiavi maschio esagonali (1,5÷10 mm)	519/285A1	25
Pinza universale, pinza regolabile, tronchese, pinza becchi lunghi e pinza grip	519/150AX	5
Giraviti per viti ad intaglio ed a croce PHILLIPS	519/324H	10
Giraviti per viti TORX	519/324TX	9
Lime a taglio mezzodolce	519/990A1	4
Martello per meccanici, mazzuola, cacciaspine, scalpello e bulino	519/382F	8
Assortimento di inserti con cricchetto reversibile	692 J32	32

~~1.273,00 €~~

660,00 €

495 PA
U04950629

142
PEZZI



Assortimento AUTORIPARAZIONE - 2 cassette

DESCRIZIONE	ART	PZ
Bussole esagonali, cricchetto (237 A), accessori 1/4 ed inserti	519/613AEA	42
Bussole esagonali, cricchetto (237 A) ed accessori 1/2	519/613CEA	22
Giraviti per viti ad intaglio ed a croce PHILLIPS	519/324H	10
Chiavi combinate (6÷24 mm) + chiavi maschio esagonali (1,5÷10 mm)	519/285A1	25
Pinza universale, pinza regolabile, tronchese, pinza becchi lunghi e pinza grip	519/150AX	5
Chiavi a T snodate con bocca esagonale (7-8-10-12-13-17 mm)	276 CE	6
Assortimento di inserti con cricchetto reversibile	692 J32	32

~~1.249,00 €~~

660,00 €

DESCRIZIONE	ART	PZ
Bussole esagonali, cricchetto (237 A), accessori 1/4 ed inserti	519 M 613AEA	46
Bussole esagonali, cricchetto (237 A) ed accessori 3/8	519 M 613BEA	20
Bussole esagonali lunghe e corte, cricchetto (237 A) ed accessori 1/2	519 M 612CLA	35
Chiavi combinate a cricchetto reversibili (8-9-10-1-12-13-14-15-16-17-18-19 mm)	519 M 285 KA	12
Chiavi combinate (6-7-8-9-10-1-12-13-14-15-16-17-18-19-22-24 mm)	519 M 285A1	17
Chiavi combinate (27-29-30-32-34 mm)	519 M 285A2	5
Chiave a rullino rapida e corta, pinza autobloccante e forbice	519 M 294B	4
Giraviti per viti ad intaglio ed a croce PHILLIPS	519 M 324H	7
Giraviti per viti TORX	519 M 324STX	8
Chiavi maschio esagonali con impugnatura (3-4-5-6-7-8-10 mm)	519 M 280HG	7
Cassetta inserti assortita e chiavi maschio esagonali / TORX	519 M 280N1	117
Pinze per anelli elastici interni ed esterni 15÷25 e 19÷60	519 M 127C	6
Pinza universale, pinza regolabile, tronchese, pinza becchi lunghi e pinza grip	519 M 150AX	5
Lime a taglio mezzodolce	519 M 990A5B	5
Martello per meccanici, mazzuola, cacciaspine, scalpello e bulino	519 M 382F	7



**NON TROVI IL TUO
ASSORTIMENTO
IDEALE?**

Configuralo su
kitplanner.usag.it

Moduli in plastica



519/127N
U05190716 **4 PEZZI**
127 N 19÷60 · 127 PN 19÷60 ·
128 N 19÷60 · 128 PN 19÷60.
117,00 € **82,00 €**



519/150AX
U05190850 **5 PEZZI**
133 AX 160 · 134 250 · 150 AX 180 ·
180 C 250 · 188 AX 160.
171,00 € **120,00 €**



519/252A1
U05190821 **11 PEZZI**
252 N 6x7-8x9-10x11-12x13-14x15-16x17-
18x19-21x23-22x24-27x29-30x32.
121,00 € **84,50 €**



519/280HG
U05191860 **7 PEZZI**
280 HG 3-4-5-6-7-8-10.
115,00 € **80,50 €**



519/280HGTS
U05191861 **7 PEZZI**
280 HGTS 3-4-5-6-7-8-10.
125,00 € **87,50 €**



519/285A1
U05190785 **25 PEZZI**
285 6-7-8-9-10-11-12-13-14-15-16-17-
18-19-22-24 280 S9 1,5÷10.
182,00 € **127,00 €**



519/285B2
U05190823 **4 PEZZI**
285 27-29-30-32.
103,00 € **72,00 €**



519/285KA1
U05190788 **12 PEZZI**
285 KA 8-9-10-11-12-13-14-15-
16-17-18-19.
243,00 € **170,00 €**



519/299
U05190760 **5 PEZZI**
299 6-7-8-10-13.
96,00 € **67,00 €**



519/322H
U05190772 **10 PEZZI**
322 0,5x3x75-0,8x4x100-1x5,5x125-
1,2x6,5x150-1,6x8x175 · 322 PH 0x75-1x100-
2x125 · 322 N 0,8x4x30 · 322 NPH 2x30.
66,50 € **46,50 €**



519/324H
U05190763 **10 PEZZI**
324 0,5x3x75-0,8x4x100-1x5,5x125-
1,2x6,5x150-1,2x8x200 · 324 PH 0x75-1x75-
2x100 · 324 N 0,8x4x35 · 324 NPH 2x35.
84,50 € **59,00 €**



519/324TX
U05190764 **9 PEZZI**
324 TX T6x50-T7x50-T8x50-T9x75 · 324 STX
T10x75-T15x75-T20x100-T25x100-T30x125.
107,00 € **75,00 €**



519/382F
U05190742 **8 PEZZI**
362 150 · 367 2x100-3x130-4x145-
5x165 · 368 4x125 · 376 35 · 382F 500.
105,00 € **73,50 €**



519/613AEA **42 PEZZI**
U05190784 237 A
235 1/4" EN 4-4,5-5-5,5-6-7-8-9-10-11-12-13-
14 · 236 1/4" 50-150 · 237 A 1/4" · 240 1/4" ·
241 1/4" · 243 1/4" · 692 S11 · 692 STX/S11 ·
684 1/4"-1/4".
215,00 € **151,00 €**



519/613BEA **22 PEZZI**
U05190747 237 A
235 3/8" E 6-7-8-9-10-11-12-13-14-15-
16-17-18-19-21-22 · 236 3/8" 125-250 ·
237 A 3/8" · 240 3/8" N · 241 3/8".
224,00 € **157,00 €**



519/613CEA **22 PEZZI**
U05190750 237 A
235 1/2" EN 10-11-12-13-14-15-16-
17-18-19-20-21-22-24-27-30-32 · 236
1/2" 125-250 · 237 A 1/2" · 240 1/2" N
· 241 1/2".
270,00 € **189,00 €**



519/990A1
U05190825 **4 PEZZI**
990 M PA/200 · 990 M PB/200
990 M PC/200 · 990 M PE/200.
60,00 € **42,00 €**



519/960
U05190753 **7 PEZZI**
207 A · 220 B1 · 960 · 966/20 · 974 · 978
A/200 · 981 A/3.
166,00 € **116,00 €**

Crea il tuo assortimento ideale su kitplanner.usag.it!

Scopri tutta la gamma di moduli in plastica su usag.it o inquadra il QR code



8 PEZZI **XL**
519/280T
U05190727
280 T 2-2,5-3-4-5-6-8-10.
163,00 € **114,00 €**



8 PEZZI **XXL**
519/276
U05190725
276 CE 7-8-10-11-13-14-17-19.
393,00 € **275,00 €**

Moduli in spugna

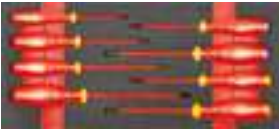

519 M 091A
U05191016 **8 PEZZI**
091 0,5x3x75-0,8x4x100-1x5,5x125
1,2x6,5x150 · 091 PH 1x100-2x125 · 091
PZ 1x100-2x125.
99,50 € **69,50 €**



519 M 127N
U05190937 **4 PEZZI**
127 N 19÷60 · 127 PN 19÷60 ·
128 N 19÷60 · 128 PN 19÷60.
135,00 € **88,00 €**



519 M 150AX
U05190965 **5 PEZZI**
133 AX 160 · 134 250 · 150 AX 180 ·
180 C 250 · 188 AX 160.
177,00 € **124,00 €**

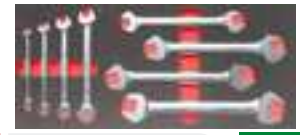

519 M 252
U05191072 **8 PEZZI**
252 N 6x7-8x9-10x11-12x13-14x15-
6x17-18x19-20x22.
76,00 € **53,00 €**

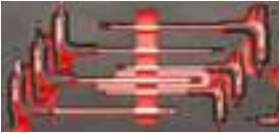

519 M 280HG
U05191945 **7 PEZZI**
280 HG 3-4-5-6-7-8-10.
121,00 € **84,50 €**

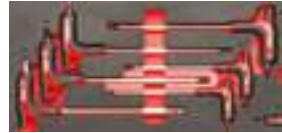

519 M 280HGTS
U05191946 **7 PEZZI**
280 HGTS 3-4-5-6-7-8-10.
132,00 € **92,50 €**



519 M 280N1
U05191013 **117 PEZZI**
280 S9 1,5-2-2,5-3-4-5-6-8-10 · 280 TX/
S8C T10-T15-T20-T25-T27-T30-T40-T45
-692 J100.
136,00 € **95,00 €**



519 M 283
U05191073 **8 PEZZI**
283 6x7-8x9-10x11-12x13-14x15-16x17-
18x19-20x22.
112,00 € **78,50 €**



519 M 285A1
U05190921 **17 PEZZI**
285 6-7-8-9-10-11-12-13-14-15-16-
17-18-19-21-22-24.
195,00 € **128,00 €**



519 M 285A2
U05190943 **5 PEZZI**
285 27-29-30-32-34.
161,00 € **104,00 €**



519 M 285KA
U05190944 **12 PEZZI**
285 KA 8-9-10-11-12-13-14-15-
16-17-18-19.
249,00 € **174,00 €**



519 M 294B
U05191015 **4 PEZZI**
135 A 250 · 207 E · 294 AC · 294 AD 250.
187,00 € **131,00 €**



519 M 324H
U05190910 **8 PEZZI**
324 0,5x3x75-0,8x4x100-1x5,5x125-
1,2x6,5x150 · 324 PH 1x100-2x125
324 D 0,6x3,5x100 324 E 1,6x8x175.
91,00 € **55,00 €**



519 M 324STX
U05190911 **7 PEZZI**
324 STX T10x75-T15x75-T20x100-
T25x100-T27x100-T30x125-T40x150.
120,00 € **77,00 €**



519 M 382F
U05190926 **7 PEZZI**
362 175 · 367 2x100-3x130-6x180
368 3x100 · 376 28 · 382F 500.
140,00 € **91,00 €**



519 M 613AEA **46 PEZZI**
U05190940 237 A
235 1/4" EN 5,5-6-7-8-9-10-11-12-13-14 · 236
1/4" 50-100 · 237 A 1/4" · 240 1/4" · 241 1/4" ·
243 1/4" · 280 LTS/S9 · 684 1/4" · 1/4" · 660 0,6-
1-1,6 · 660 E 3-4-5-6-8 · 660 PH 1-2-3 · 660 PZ
1-2-3 · 660 STX T15-T20-T25-T27-T30-T40.
268,00 € **188,00 €**



519 M 613BEA **20 PEZZI**
U05190928 237 A
235 3/8" E 7-8-9-10-11-12-13-14-15-16-
17-18-19-21-22 · 236 3/8" 125-250 ·
237 A 3/8" · 240 3/8" N · 241 3/8".
238,00 € **155,00 €**



519 M 613CEA **23 PEZZI**
U05190942 237 A
235 1/2" EN 8-10-11-12-13-14-15-16-
17-18-19-21-22-23-24-27-30-32 · 236
1/2" 125-250 · 237 A 1/2" · 240 1/2" N
· 241 1/2".
295,00 € **207,00 €**



519 M 990A5MD
U05191011 **5 PEZZI**
990 M PA/200 · 990 M PB/200 · 990 M
PC/200 · 990 M PD/200 · 990 M PE/200.
80,00 € **56,00 €**



**Scopri tutta la gamma
di moduli in spugna su
usag.it o inquadra
il QR code**



519 M 280T
U05191059 **8 PEZZI** **XL**
280 T 2-2,5-3-4-5-6-8-10.
173,00 € **123,00 €**

519 M 276
U05190936 **7 PEZZI** **XXL**
276 CE 7-8-10-11-13-17-19.
371,00 € **265,00 €**

NUOVA GAMMA 002

L'ECCELLENZA PER IL
LAVORO DI TUTTI I GIORNI.



002 MA
U00020031

181
PEZZI

11,5 kg 460 mm 158 mm 385 mm

Valigia con assortimento per manutenzione

~~797,00 €~~ **459,00 €**

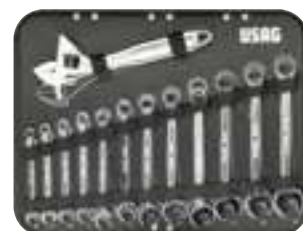

002 TMA
U00020035

181
PEZZI

13 kg 470 mm 200 mm 370 mm

Trolley con assortimento per manutenzione

~~807,00 €~~ **479,00 €**

Valigie manutenzione



Novità

002 MAUD
U00024706W

65
PEZZI

10 kg | mm | 460
158
385

Valigia con assortimento per manutenzione

~~995,00 €~~ **499,00 €**



12V XR
2 BATTERIE 12V
3.0 AH INCLUSE



1000 V

Novità

002 MEUD
U00025706W

65
PEZZI

10 kg | mm | 460
158
385

Valigia con assortimento per elettrotecnica

~~1.054,00 €~~ **539,00 €**



12V XR
2 BATTERIE 12V
3.0 AH INCLUSE



1000 V

Novità

002 ME
U00020017

181
PEZZI

11,5 kg | mm | 460
158
385

Valigia con assortimento per elettrotecnica

~~849,00 €~~ **499,00 €**





I PRODOTTI CHE

RESISTENZA ALLA TORSIONE STATICA

+30% di coppia rispetto alla norma ISO 3315 grazie al nottolino brevettato.

RESISTENZA A FATICA

Dura il doppio dei normali cricchetti del mercato grazie alla protezione IP51.

237 A

**CRICCHETTO
REVERSIBILE**



**Vai a pagina
53**

285 KA

**CHIAVE COMBINATA
A CRICCHETTO**



ANELLO IN ACCIAIO ARMONICO INTEGRATO

nell'occhio poligonale mantiene la posizione sul dado durante la manovra.

**Vai a pagina
52**

443 N

**CHIAVE
FILTRI OLIO**



SERRAGGIO AUTOMATICO DEL NASTRO

**Vai a pagina
80**

FANNO LA DIFFERENZA!

324
GIRAVITE



LAMA RINFORZATA

Acciaio al cromo silicio vanadio per la massima resistenza meccanica.

PUNTA AL TOP

Finitura zincata. Geometria perfetta. Trattamento anti corrosione.

Vai a pagina
49

TAGLIO AL TOP

Taglia fino a Ø 2 mm di filo armonico con il 30% in meno di forza rispetto al valore massimo indicato dalle normative europee ISO5749 (tronchesi) - ISO5746 (pinze).

150 AX

PINZA
UNIVERSALE



Vai a pagina
54

280 T
CHIAVE A T



SICUREZZA GARANTITA

+30% resistenza alla torsione rispetto alla norma ISO 2936. Raggiunta la coppia di rottura, la chiave si deforma senza spezzarsi.

Vai a pagina
51

285
CHIAVE
COMBINATA



TOP PERFORMANCE

Resistenza alla torsione statica di anello e forchetta: +50% rispetto alla norma ISO 1711-1.

Vai a pagina
52

207 E
FORBICE PER
ELETTRICISTI



L'UNICA CON STRUTTURA INTEGRALE IN ACCIAIO INOX

resiste alla flessione fino a 180 kg.

Vai a pagina
66



GIRAVITE ELETTRICO 324 XP

LA VELOCITÀ DELLA BATTERIA, LA SENSIBILITÀ DEL TUO POLSO.



Nylon ad alta resistenza



EN 60529



Elastici portainseriti



324 XP/B16

U03240801

16
PEZZI

Giravite elettrico in astuccio con inserti

- Astuccio in nylon ad alta resistenza.
- Elastici portainseriti.
- Tasca interna per il cavo USB-C.
- Gancio per cintura.

~~249,00 €~~

102,00 €

AVVITA LUI. STRINGI TU.



300
Giri/min
0,9 Nm

LA SUA VELOCITÀ
Avvita e svita velocemente con i 300 giri/min del motore elettrico.

LA TUA SENSIBILITÀ
Finisci il serraggio con la sensibilità di un giravite manuale.

10 Nm



YouTube



CRICCHETTO INTEGRATO



333 K/SH8

U03330142

Assortimento COMBIDRIVE con inserti

- Fornito con una selezione di 6 inserti da 1/4".

DESCRIZIONE	ARTICOLO/MISURA	PZ
Impugnatura Combidrive	333 K	1
Lama portainseriti magnetica	333 1/4 MG	1
Inserti ad intaglio	660/0,6x3,5-1x5,5	2
Inserti a croce PH	660 PH 1-2	2
Inserti esagonali	660 E 3-4	2

~~63,50 €~~

43,00 €



CRICCHETTO INTEGRATO



Fornito senza inserti USAG 660

10
PEZZI



333 K/SB10

U03330143

Assortimento COMBIDRIVE in astuccio di nylon

- Fornito con una selezione di lame.
- Include un astuccio da cintura in nylon.

DESCRIZIONE	ARTICOLO/MISURA	PZ
Impugnatura Combidrive	333 K	1
Lama portainseriti magnetica	333 1/4 MG	1
Lame reversibili ad intaglio	333 I 0,6x3,5-0,8x4/1x5,5-1,2x6,5	2
Lame reversibili a croce PH	333 PH 0-1/2-3 333 TX T8-T9	2
Lame reversibili TORX®	333 STX T10-T15/T20-T25/ T30-T40	4

~~113,00 €~~

76,00 €



GIRAVITI 324



8
PEZZI

324 SH8

U03240650

Serie di 8 giraviti per viti con intaglio e impronta a croce PHILLIPS®

- 324 D/0,4x2,5x50.
- 324/0,5x3x75-0,8x4x100-1x5,5x125-1,2x6,5x150.
- 324 PH/0x75-1x75-2x100.

~~54,50 €~~

34,50 €



12
PEZZI

324 SH12

U03240651

Serie di 12 giraviti per viti con intaglio, impronta a croce PHILLIPS® e impronta a croce POZIDRIV® - SUPADRIV®

- 324 D/0,4x2,5x50.
- 324/0,5x3x75-0,8x4x100-1x5,5x125-1,2x6,5x150.
- 324 N/1x5,5x35.
- 324 PH/0x75-1x75-2x100.
- 324 NPH/2x35.
- 324 PZ/1x75-2x100.

~~92,50 €~~

60,50 €



7
PEZZI

324 STX/S7

U03240662

Serie di 7 giraviti con impronta TORX® Tamper Resistant

- 324 STX T10x75-T15x75-T20x100-T25x100-T27x100-T30x125-T40x150.

~~95,00 €~~

61,00 €

GIRAVITI 091 ISOLATI 1000 V - EN 60900.

SLIM



5
PEZZI

091 D/SH5

U00910119

Serie di 5 giraviti SLIM per viti con intaglio e per viti con impronta a croce PHILLIPS®

- 091 D/0,6x3,5x100-0,8x4x100-1x5,5x125.
- 091 DPH/1x100-2x125.

~~61,00 €~~

42,70 €



5
PEZZI

091 SH5

U00910100

Serie di 5 giraviti per viti con intaglio e per viti con impronta a croce PHILLIPS®

- 091/0,5x3x75-0,8x4x100-1x5,5x125.
- 091 PH/1x100-2x125.

~~50,00 €~~

35,00 €



8
PEZZI

091 SH8

U00910106

Serie di 8 giraviti per viti con intaglio, per viti con impronta a croce PHILLIPS® e impronta a croce POZIDRIV® - SUPADRIV®

- 091/0,5x3x75-0,8x4x100-1x5,5x125-1,2x6,5x150.
- 091 PH/1x100-2x125.
- 091 PZ/1x100-2x125.

~~86,00 €~~

59,50 €

Inserti e chiavi maschio



322 SH7 U03220254

Serie di 7 giraviti per viti con intaglio e impronta a croce PHILLIPS®

- 322//0,4x2x50-0,5x3x75-0,8x4x100-1,5,5x100-1,2x6,5x150.
- 322 PH/1x100-2x125.

~~39,00 €~~

27,30 €



322 SH10 U03220255

Serie di 10 giraviti per viti con intaglio, impronta a croce PHILLIPS® e impronta a croce POZIDRIV®

- 322/0,4x2x50-0,5x3x75-0,8x4x100-1x5,5x100-1,2x6,5x150.
- 322 PH/0x75-1x100-2x125.
- 322 PZ/1x100-2x125

~~58,00 €~~

40,60 €



YouTube



210 MM
DI LUNGHEZZA

280 TQ U02800800

Chiave a T portainseri

- Doppio portainseri esagonale magnetico da 1/4".
- Capacità massima del portainseri: inserto per viti esagonali incassate misura 6 mm oppure viti TORX® misura T40.
- Estremità con quadro portabussole da 1/4".
- Acciaio speciale altamente legato al cromo vanadio.
- Esecuzione cromata.

~~38,80 €~~

27,20 €

Supporti compatti
con sistema di
estrazione rapida



GUARDA IL VIDEO
DIMOSTRATIVO



YouTube

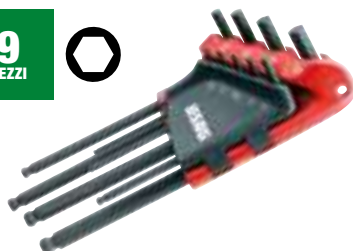

280 LTS/S9 U02800084

Serie di 9 chiavi maschio esagonale lunghe testa sferica

- 280 LTS/1,5-2-2,5-3-4-5-6-8-10 mm.

~~35,60 €~~

22,50 €

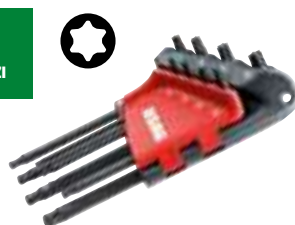

280 LTSTX/S8 U02800078

Serie di 8 chiavi maschio lunghe testa sferica TORX®

- 280 LTSTX/T10-T15-T20-T25-T27-T30-T40-T45.

~~64,50 €~~

45,10 €

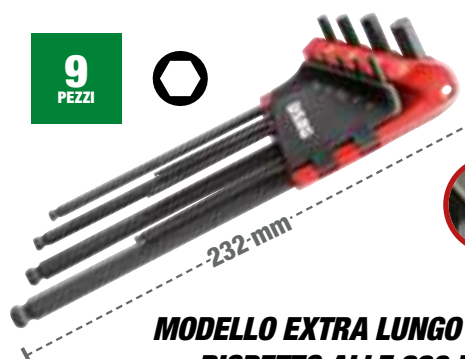

280 XLTS/S9 U02800184

Serie di 9 chiavi maschio esagonale extra-lunghe a testa sferica

- 280 XLTS/1,5-2-2,5-3-4-5-6-8-10 mm.

~~39,60 €~~

27,70 €

MODELLO EXTRA LUNGO +30%
RISPETTO ALLE 280 LTS



7
PEZZI



280 T/SE7
U02800903

Serie di 7 chiavi a T con maschio esagonale
• 280 T/2-2,5-3-4-5-6-8 mm.

~~126,00 €~~ **88,00 €**

88,00 €

6
PEZZI



280 TTS/SE6
U02800760

Serie di 6 chiavi a T maschio esagonali con testa sferica
• 280 TTS/2,5-3-4-5-6-8 mm.

~~110,00 €~~ **77,00 €**

77,00 €



Testa sferica

6
PEZZI



280 TK/SE6
U02800020

Serie di 6 chiavi a T maschio esagonale con traversino scorrevole
• 280 TK/2,5-3-4-5-6-8 mm.

~~121,00 €~~ **87,00 €**

87,00 €

Traversino scorrevole

6
PEZZI



280 HG/SE6
U02801460

Serie di 6 chiavi maschio esagonale con impugnatura
• 280 HG/2,5-3-4-5-6-8 mm.

~~83,00 €~~ **58,00 €**

58,00 €



6
PEZZI



280 HGTS/SE6
U02801463

Serie di 6 chiavi maschio esagonale a testa sferica con impugnatura
• 280 HGTS/2,5-3-4-5-6-8 mm.

~~91,50 €~~ **64,00 €**

64,00 €

Testa sferica



6
PEZZI



280 HATX/SE6
U02800464

Serie di 6 chiavi maschio con impugnatura per viti con impronta TORX®
• 280 HATX/T8-T10-T15-T20-T25-T30.

~~64,00 €~~ **44,80 €**

44,80 €



XGRIP



**VITI O DADI SPANATI?
NON BESTEMMIARE!**
Vai a pagina 6: abbiamo la soluzione per te!

Chiavi di manovra



YouTube

8
PEZZI

8÷19 mm



285 DS8

U02850863

Serie di 8 chiavi combinate

- 285/8-10-11-12-13-14-17-19 mm.
- Fornita con supporto in plastica.

~~80,50 €~~

52,00 €

12
PEZZI

7÷19 mm

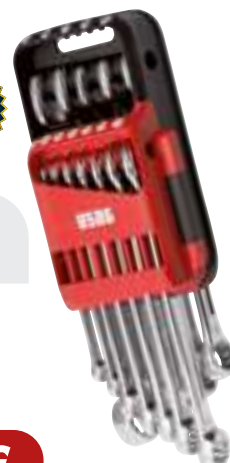

285 DS12

U02850864

Serie di 12 chiavi combinate

- 285/7-8-10-11-12-13-14-15-16-17-18-19 mm.
- Fornita con supporto in plastica.

~~120,00 €~~

81,00 €

26
PEZZI

6÷32 mm



285 SE26

U02850861

Serie di 26 chiavi combinate

- 285/6-7-8-9-10-11-12-13-14-15-16-17-18-19-20-21-22-23-24-25-26-27-28-29-30-32 mm.

~~358,00 €~~

242,00 €

5
PEZZI

8÷19 mm



285 KA/SE5

U02856074

Serie di 5 chiavi combinate a cricchetto con anello di tenuta

- 285 KA/8-10-13-17-19 mm.

~~98,00 €~~

69,00 €



YouTube

8
PEZZI

8÷19 mm



285 KA/DS8

U02856058

Serie di 8 chiavi combinate a cricchetto con anello di tenuta

- 285 KA/8-10-11-12-13-14-17-19 mm.
- Fornita con supporto in plastica.

~~162,00 €~~

108,00 €

12
PEZZI

7÷19 mm



285 KA/DS12

U02856062

Serie di 12 chiavi combinate a cricchetto con anello di tenuta

- 285 KA/7-8-10-11-12-13-14-15-16-17-18-19 mm.
- Fornita con supporto in plastica.

~~244,00 €~~

171,00 €

XGRIP



VITI O DADI SPANATI? NON BESTEMMIARE!

Vai a pagina 6: abbiamo la soluzione per te!



5
PEZZI

8÷19 mm

285 KF/SE5

U02856160

Serie di 5 chiavi combinate a cricchetto snodate

- 285 KF/8-10-13-17-19 mm.

~~115,00 €~~

80,00 €



8
PEZZI

8÷19 mm

285 KF/DS8

U02856158

Serie di 8 chiavi combinate a cricchetto snodate

- 285 KF/8-10-11-12-13-14-17-19 mm.
- Fornita con supporto in plastica.

~~189,00 €~~

132,00 €

8
PEZZI

6÷22 mm

252 N/SR8

U02520862

Serie di 8 chiavi a forchetta doppie

- 252 N/6x7-8x9-10x11-12x13-14x15-16x17-18x19-20x22 mm.

~~67,50 €~~

43,50 €

UNI 6743 7÷19 mm

8
PEZZI

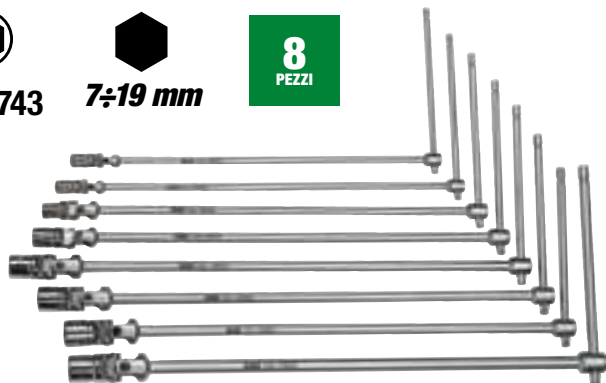

276 CE/SE8

U02760484

Serie di 8 chiavi a T snodate

- 276 CE/7-8-10-12-13-14-17-19 mm.

~~381,00 €~~

267,00 €

LO SNODO CARDANICO USAG

- Molla di frizione interna per il perfetto preposizionamento della bussola.
- Bussola e cardano fissati con un perno in acciaio ribadito per la massima affidabilità.



23
PEZZI

1 1/2"



YouTube



19
PEZZI

1 1/4"

606 1/2" EA

U06060302



3 kg | 60 mm | 330 | 215

Assortimento in cassetta di ABS con bussole esagonali

- Cassetta in ABS ad alta resistenza con sistema di chiusura rapida.

DESCRIZIONE	ART./MISURA	PZ.
Chiavi a bussola con bocca esagonale	235 1/2 EN 8-9-10-11-12-13-14-15-16-17-18-19-21-22-23-24-27-30-32	19
Prolunghe	236 1/2 125-250	2
Snodo cardanico	241 1/2	1
Cricchetto reversibile certificato IP51	237 A 1/2	1

~~267,00 €~~

160,00 €

606 1/4" EA

U06060101



1 kg | 60 mm | 210 | 130

Assortimento in cassetta di ABS con bussole esagonali

- Cassetta in ABS ad alta resistenza con sistema di chiusura rapida.

DESCRIZIONE	ART./MISURA	PZ.
Chiavi a bussola con bocca esagonale	235 1/4 EN 4-4,5-5-5,5-6-7-8-9-10-11-12-13-14	13
Prolunghe	236 1/4 50-100	2
Snodo cardanico	241 1/4	1
Leva a T con attacco quadro scorrevole	240 1/4	1
Portabussole con impugnatura	243 1/4	1
Cricchetto reversibile certificato IP51	237 A 1/4	1

~~140,00 €~~

83,00 €

Pinze e tronchesi



YouTube



150 AX/SE3

U01500201

3

PEZZI

Assortimento pinze e tronchesi

- Pinza universale 150 AX 180.
- Pinza a becchi mezzotondi lunghissimi diritti 133 AX 160.
- Tronchesi a grande effetto a tagliente diagonale 188 AX 160.

~~102,00 €~~ **71,00 €**



1000 V

085 EX/SE3

U00850121

3

PEZZI

Assortimento pinze e tronchesi isolati 1000 V

- Pinza universale 085 EX 180.
- Pinza a becchi mezzotondi lunghissimi diritti 081 EX 160.
- Tronchesi a grande effetto a tagliente diagonale 087 EX 160.

~~137,00 €~~ **96,00 €**



**CAPACITÀ
MAX.
80 mm**



135 B

U01350510

Pinza regolabile autobloccante a cremagliera con ganasce lunghe

- Ganasce forgiate.
- Dentatura studiata per una presa perfetta anche su tondo.
- Sistema di apertura brevettato ed integrato nei manici.
- Rullino di regolazione della presa integrato sul manico superiore.
- Cremagliera a 5 posizioni.

~~79,50 €~~ **55,50 €**

**CAPACITÀ
MAX.
135 mm**



135 C

U01350530

Pinza regolabile autobloccante a cremagliera a grande capacità

- Ganasce forgiate.
- Dentatura studiata per una presa perfetta anche su tondo.
- Sistema di apertura brevettato ed integrato nei manici.
- Rullino di regolazione della presa integrato sul manico superiore.
- Cremagliera a 5 posizioni.

~~97,00 €~~ **68,00 €**

TAGLIO RASO



Per materiale plastico



**TAGLIO RASO
PIEGATO A 45°**



186 C

Tronchesi a tagliente raso diagonale per materiali plastici

- Becchi arrotondati ribassati.
- Molla di richiamo.
- Manici rivestiti con guaina in PVC.
- Corpo in acciaio speciale altamente legato al cromo vanadio.
- Esecuzione brunita testa pulita.

CODICE	L	TAGL.	
U01860060	150 mm	22 mm	40,50 € 25,00 €
U01860061	180 mm	27 mm	45,50 € 28,50 €



187 C

U01870001

Tronchesi a tagliente raso diagonale piegato a 45° per materiali plastici

- Becchi arrotondati ribassati.
- Molla di richiamo.
- Manici rivestiti con guaina in PVC.
- Corpo in acciaio speciale altamente legato al cromo vanadio.
- Esecuzione brunita testa pulita.

~~61,00 €~~ **42,50 €**

**PER
MATERIALE
PLASTICO**

PERFETTI PER IL TAGLIO PIANO E A FILO DELLE SUPERFICI DELLE MATEROZZE, TIPICO DELLO STAMPAGGIO A INIEZIONE

NUOVE PINZE AUTOBLOCCANTI AUTOMATICHE



Garantiscono una presa ottimale sia su elementi piatti che tondi



134 K 150

Tondi MAX | Piatti MAX
Ø 25 mm | 20 mm

134 K 250

Tondi MAX | Piatti MAX
Ø 38 mm | 30 mm



SEMPRE PRONTE, ZERO REGOLAZIONI

Funzione di regolazione automatica brevettata: la pinze si adattano automaticamente allo spessore del pezzo.

135 K

Tondi MAX | Piatti MAX
Ø 25 mm | 20 mm



134 K

Pinza autobloccante automatica con ganasce concave

CODICE	L	APERTURA	38,60 €	27,00 €
U01340150	150 mm	31 mm		
U01340250	250 mm	48 mm	50,00 €	35,00 €

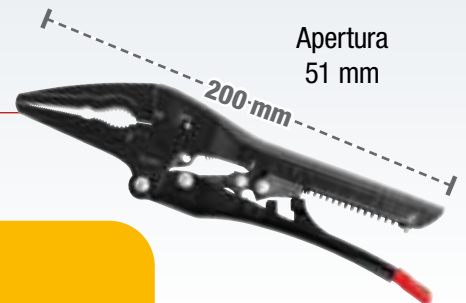

135 K

U01350175

Pinza autobloccante automatica con ganasce lunghe

~~38,60 €~~ **27,00 €**

TRONCHESE A GRANDE EFFETTO

20% DI SFORZO IN MENO RISPETTO AD UN TRONCHESE STANDARD.

TAGLIO MAX.
Ø 3 mm



FULCRO DECENTRATO

aumenta l'effetto leva riducendo molto lo sforzo richiesto per il taglio.

189 G

U01890200

ISO 5746

Tronchese a grande effetto con fulcro decentrato

- Presa sicura sul filo durante il taglio, grazie al design delle ganasce.
- Perfetto sia per tagli impegnativi che per lavori di taglio ripetitivi su diametri più piccoli.
- Sistema di presa del filo integrato nel retro della testa.
- Impugnature ergonomiche bimateriali.
- Esecuzione verniciata trasparente.

~~58,50 €~~

40,00 €

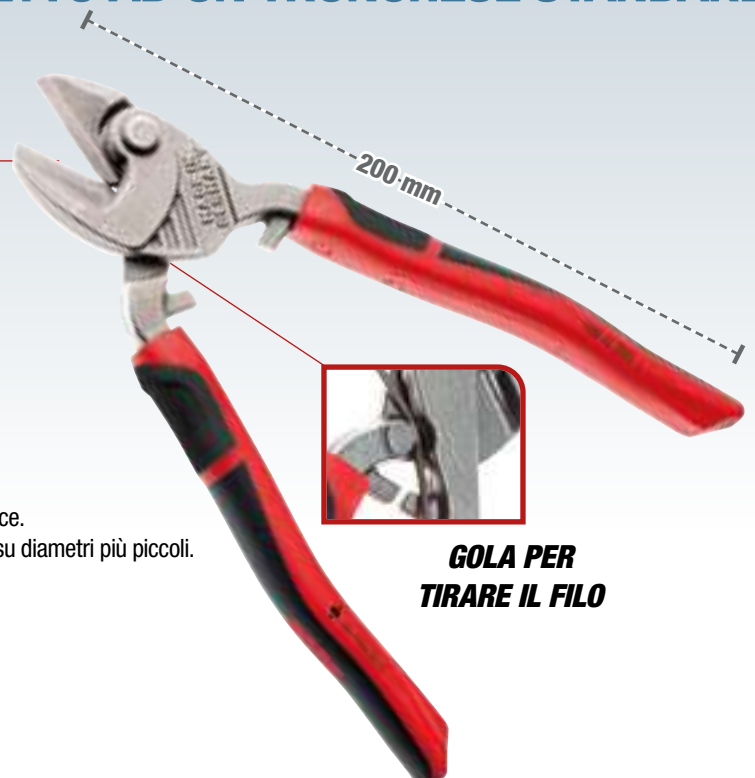

GOLA PER TIRARE IL FILO

Pinze per anelli di tenuta

GAMMA 127 N E 128 N

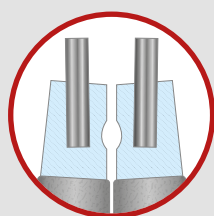

MASSIMA RESISTENZA

Punte in acciaio armonico inserite nei becchi.

GAMMA 127 C E 128 C

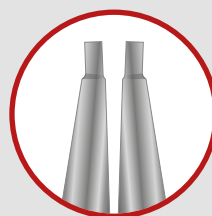

MASSIMA ACCESSIBILITÀ

Punte e becchi in corpo unico.



4
PEZZI



127 N/SE4S

U01270046

10÷25 mm

Serie 4 pinze per anelli elastici

- Pinze per anelli elastici interni 127 N 12÷25-127 PN 12÷25.
- Pinze per anelli elastici esterni 128 N 10÷25-128 PN 10÷25.

~~102,00 €~~

71,50 €



4
PEZZI



127 C/SE4S

U01270045

10÷25 mm

Serie 4 pinze per anelli elastici

- Pinze per anelli elastici interni 127 C 12÷25-127 CP 12÷25.
- Pinze per anelli elastici esterni 128 C 10÷25-128 CP 10÷25.

~~85,50 €~~

59,50 €

127 N/SE4

U01279000P

19÷60 mm

Serie 4 pinze per anelli elastici

- Pinze per anelli elastici interni 127 N 19÷60-127 PN 19÷60.
- Pinze per anelli elastici esterni 128 N 19÷60-128 PN 19÷60.

~~111,00 €~~

77,50 €

127 C/SE4

U01270040

19÷60 mm

Serie 4 pinze per anelli elastici

- Pinze per anelli elastici interni 127 C 19÷60-127 CP 19÷60.
- Pinze per anelli elastici esterni 128 C 19÷60-128 CP 19÷60.

~~93,00 €~~

65,00 €

PINZE A CREMAGLIERA PER ANELLI ELASTICI



85÷200 mm

MECCANISMO A CREMAGLIERA

che consente di rimuovere o installare senza sforzo e con precisione, anelli elastici di grandi dimensioni



PUNTE RIMOVIBILI E INTERCAMBIABILI
fissate tramite grano con esagono da 5 mm



127 M

U01270051



Pinza a cremagliera a becchi dritti per anelli elastici interni di grandi dimensioni

~~84,00 €~~

58,50 €



127 MP

U01270050



Pinza a cremagliera a becchi piegati a 45° per anelli elastici interni di grandi dimensioni

~~84,00 €~~

58,50 €

128 M

U01280051



Pinza a cremagliera a becchi dritti per anelli elastici esterni di grandi dimensioni

~~84,00 €~~

58,50 €

128 MP

U01280050



Pinza a cremagliera a becchi piegati a 45° per anelli elastici esterni di grandi dimensioni

~~84,00 €~~

58,50 €

KIT DI UTENSILI PER ANELLI "TIPO E"



5 PEZZI



LAME INTERCAMBIABILI

INSERT

lato di montaggio

RELEASE

lato di smontaggio



126 E

U01260001

Kit di utensili per anelli di sicurezza tipo E

~~34,00 €~~

23,50 €



6-7-8-9 mm

PINZA REGOLABILE AUTOMATICA 181 AX PRESA PERFETTA, SENZA REGOLAZIONE.

**APERTURA
MAX 60 mm**

**GANASCE
CON DENTI TEMPRATI**
per una presa sicura e durevole.

SISTEMA DI REGOLAZIONE AUTOMATICO

Stringi le impugnature e si adatta alla forma ed alla dimensione del componente da manovrare.

**BLOCCO DI CHIUSURA
INTEGRATO**

Novità

181 AX
U01810250

Pinza multipresa a
regolazione automatica

~~79,00 €~~

55,00 €

**IMPUGNATURE
ERGONOMICHE
BIMATERIALE**

Novità



PINZA REGOLABILE 180 AX CON SISTEMA DI CHIUSURA RAPIDA.

**GANASCE CON
DENTI TEMPRATI**
per una presa sicura
e durevole.

SISTEMA DI CHIUSURA RAPIDA

senza premere il pulsante.



Novità

Manici in PVC per il
modello da 300 mm.

180 AX

Pinze regolabili semiautomatiche

ARTICOLO	CODICE	L	APERTURA		
180 AX 180	U01800120	180 mm	40 mm	50,00 €	35,00 €
180 AX 250	U01800121	250 mm	60 mm	50,00 €	35,00 €
180 CX 300	U01800222	300 mm	76 mm	70,00 €	49,00 €

Novità

**IMPUGNATURE
ERGONOMICHE
BIMATERIALE**



YouTube

**PINZA E CHIAVE
IN UN UNICO
UTENSILE.**



174 CX

Pinza chiave regolabile

CODICE	L	APERTURA	72,00 €	50,00 €
U01740000	180 mm	43 mm	72,00 €	50,00 €
U01740001	250 mm	58 mm	78,00 €	55,00 €
U01740002	300 mm	73 mm	102,00 €	71,00 €



**SISTEMA
DI CHIUSURA RAPIDA**
senza premere il pulsante.

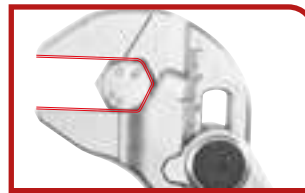

BECCHI PIATTI E PARALLELI
Battuta sagomata
per far presa su 4 lati dell'esagono.

**APERTURA
MAGGIORATA +20%**



YouTube



294 AD

Chiavi a rullino con regolazione rapida

- Si regola rapidamente arretrando il rullino.
- Grande capacità: apertura +20% rispetto allo standard.
- Doppia scala graduata: millimetri e pollici.
- Testa inclinata di 22°.
- Rullino in acciaio.
- Asola di aggancio.
- Finitura cromata.

CODICE	L	APERTURA	19,90 €	13,90 €
U02940011	110 mm - 4"	17 mm	19,90 €	13,90 €
U02940012	150 mm - 6"	23 mm	20,90 €	14,60 €
U02940013	200 mm - 8"	33 mm	24,90 €	17,40 €
U02940014	250 mm - 10"	38 mm	31,60 €	22,10 €
U02940015	300 mm - 12"	41 mm	41,60 €	29,10 €
U02940016	380 mm - 15"	50 mm	76,00 €	53,00 €
U02940017	460 mm - 18"	63 mm	126,00 €	88,00 €



**ARRETRI IL RULLINO,
REGOLI RAPIDAMENTE.**

**RUOTI IL RULLINO,
REGOLI CON PRECISIONE.**



**APERTURA
MAX 34 mm**

Solo 150 mm

294 AC

U02940010

Chiave regolabile a rullino corta

- Lunghezza ridotta del 46% rispetto ad una chiave standard.
- Apertura ganasce pari ad una chiave a rullino da 12".
- Leggera e compatta per un'ottima accessibilità.
- Regolazione tramite rullino in acciaio.
- Scala millimetrata sulla testa della chiave.
- Finitura cromata.

~~24,80 €~~ **17,40 €**



**LUNGHEZZA RIDOTTA
DEL 46% RISPETTO AD
UNA CHIAVE STANDARD**



YouTube



MINI KIT PER IL SERRAGGIO

Dimensioni compatte. Prestazioni al top!

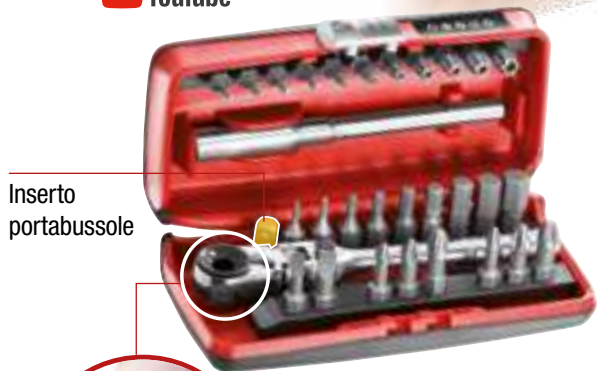

Inserto portabussole

31 PEZZI

1/4"



350 g | mm | 120 | 30 | 60



606 1/4" SK U06060012

Assortimento inserti con cricchetto reversibile

DESCRIZIONE	ART./MISURA	PZ.
Cricchetto reversibile	237 1/4" SFK	1
Inserti ad intaglio	660 0,5x4-1x5,5	2
Inserti esagonali	660 E 1,5-2-2,5-3-4-5-6-7-8	9
Inserti a croce Phillips®	660 PH 1-2-3	3
Inserti a croce Pozidriv® - SUPadriv®	660 PZ 1-2-3	3
Raccordo portainseri	660 Q 1/4"	1
Inserti TORX® Tamper Resistant	660 STX T10-T15-T20-T25-T27-T30-T40	7
Inserti TORX®	660 TX T6-T7-T8-T9	4
Prolunga magnetica	672 1/4" MG 100	1

~~77,50 €~~ **54,50 €**



11 mm

11 PEZZI

1/4"



265 g | mm | 120 | 30 | 60

5,5-6-7-8-9-10-11-12-13-14 mm

610 1/4" EFK U06100001

Assortimento bussole ribassate con cricchetto reversibile

~~93,00 €~~ **65,00 €**



YouTube

BUSSOLE ESAGONALI RIBASSATE

Garantiscono il doppio dell'accessibilità rispetto all'utilizzo di un cricchetto standard.



237 1/4" SK U02370062

Cricchetto reversibile con prolunga

- Testa snodata con movimento di 180°.
- Leva di inversione integrata.
- Funzione cricchetto: massima accessibilità grazie alla testa compatta ed allo snodo regolabile.
- Funzione chiave a T: la prolunga diventa un traversino e puoi usare il cricchetto come una chiave a T portainseri.

~~37,80 €~~ **26,50 €**



1/4"



17
PEZZI

3/4"

120
DENTI



612 3/4" EB
U06120017



13 kg | mm | 425
83
395

Assortimento in cassetta di lamiera con bussole esagonali

DESCRIZIONE	ART./MISURA	PZ.
Chiavi a bussola con bocca esagonale	235 3/4 N 22-23-24-26-27-28-30-32-36-38-41-46-50	13
Prolunghe	236 3/4 200-400	2
Leva a T scorrevole	240 3/4 N	1
Cricchetto reversibile con meccanismo sigillato 120 denti	237 B 3/4	1

~~610,00 €~~

427,00 €

612 3/4" B
U06120016



**BUSSOLE
POLIGONALI**

Assortimento in cassetta di lamiera con bussole poligonali

~~613,00 €~~

427,00 €

RIDUTTORI



3
PEZZI

246 R/S3
U02460400

Set 3 raccordi riduttori

~~49,20 €~~

30,00 €

AUMENTATORI

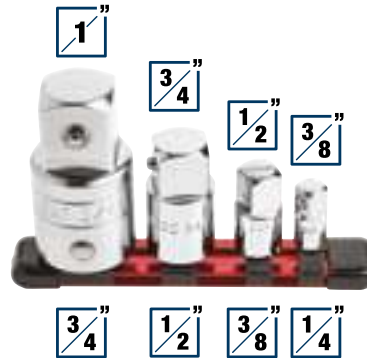

4
PEZZI

247 A/S4
U02470400

Set 4 raccordi aumentatori

~~67,00 €~~

40,00 €

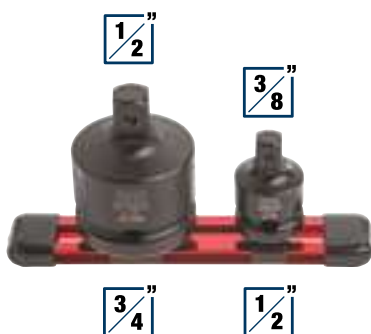

2
PEZZI

246 RM/S2
U02460500

Set 2 raccordi riduttori macchina

~~52,50 €~~

30,00 €

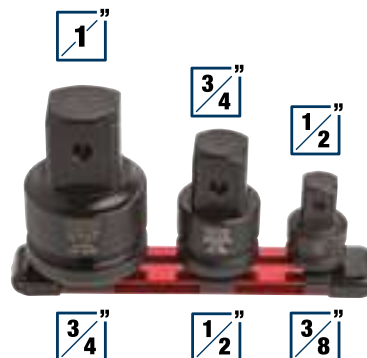

3
PEZZI

247 AM/S3
U02470500

Set 3 raccordi aumentatori macchina

~~76,00 €~~

50,00 €

CHIAVI DINAMOMETRICHE 810 SA - 811 SA CON LETTURA DIRETTA DELLA COPPIA DI SERRAGGIO.



CRICCHETTO REVERSIBILE
con meccanismo a 72 denti.

MECCANISMO A SCATTO
con molla di compressione.



YouTube

MECCANISMO SIGILLATO.
IL TOP DELLA RESISTENZA.

GHIERA DI REGOLAZIONE
con ritorno automatico

IMPUGNATURA CONICA
in bimatériale e antiscivolo.



**SERRAGGI
DESTROSI**

PRECISIONE
±4%

3/8"

1/2"

810 SA ISO 6789

Chiave dinamometrica a lettura diretta con cricchetto reversibile IP 51
• Include certificato di taratura e dichiarazione REACH (SVHC).

ARTICOLO	CODICE	CAPACITÀ	□	L (mm)	RISOL.		
810 SA 50	U08105102	10÷50 Nm	3/8"	350	0,25	221,00 €	159,00 €
810 SA 100	U08105103	20÷100 Nm	1/2"	410	0,5	221,00 €	159,00 €
810 SA 200	U08105105	40÷200 Nm	1/2"	475	1,0	221,00 €	159,00 €
810 SA 340	U08105106	60÷340 Nm	1/2"	630	1,0	254,00 €	183,00 €



**SERRAGGI
DESTROSI
E SINISTRORSI**

Cricchetto
amovibile

PRECISIONE
±4%

3/8"

1/2"

811 SE ISO 6789

Chiave dinamometrica a lettura diretta con cricchetto amovibile
• Include certificato di taratura e dichiarazione REACH (SVHC).

ARTICOLO	CODICE	CAPACITÀ	□	○	L (mm)	RISOL.		
811 SE 50	U08115012	10÷50 Nm	3/8"	9x12	370	0,25	285,00 €	199,00 €
811 SE 100B	U08115013	20÷100 Nm	3/8"	9x12	430	0,5	285,00 €	199,00 €
811 SE 100C	U08115015	20÷100 Nm	1/2"	9x12	430	0,5	287,00 €	201,00 €
811 SE 200	U08115017	40÷200 Nm	1/2"	14x18	510	1,0	292,00 €	204,00 €
811 SE 340	U08115018	60÷340 Nm	1/2"	14x18	665	1,0	325,00 €	227,00 €

BARRE DINAMOMETRICHE 811 LB

L'EQUILIBRIO PERFETTO TRA PRECISIONE E RESISTENZA.



ATTACCO RAPIDO

9X12 o 14X18 per accessori e teste a cricchetto.

SCALA GRADUATA

incisa sul tubo in acciaio.

NONIO

in acciaio.

GHIERA DI REGOLAZIONE

con ritorno automatico.

MECCANISMO A SCATTO
con molla di compressione.

IMPUGNATURA
in bimatériale antiscivolo.

Precisa
± 2%

**PRECISIONE TESTATA
IN FABBRICA.**

Resistente
50.000 scatti

**TEST DI RESISTENZA
DEL MECCANISMO.**

Come da Normativa ISO 6789, le barre dinamometriche USAG 811 LB sono testate una ad una in produzione, prima di essere confezionate.

Queste barre riescono a mantenere una soglia di precisione tra il ±2% ed il ±4% anche dopo 5.000 serraggi.



YouTube



**SERRAGGI
DESTROSI
E SINISTRORSI**

PRECISIONE
±2%

811 LB

ISO 6789

Barre dinamometriche a scatto

ARTICOLO	CODICE	CAPACITÀ	□	L	RISOL.		
811 LB 50	U08115021	10÷50 Nm	9x12 mm	357 mm	1 Nm	300,00€	210,00 €
811 LB 100	U08115023	20÷100 Nm	9x12 mm	437 mm	1 Nm	345,00€	241,00 €
811 LB 200	U08115024	40÷200 Nm	14x18 mm	515 mm	1 Nm	359,00€	251,00 €
811 LB 350	U08115025	70÷350 Nm	14x18 mm	725 mm	2 Nm	419,00€	293,00 €



**SERRAGGI
DESTROSI
E SINISTRORSI**

Cricchetto
amovibile

PRECISIONE
±2%

3/8"

1/2"

811 LBE

ISO 6789

Chiavi dinamometriche a scatto con cricchetto reversibile amovibile

ARTICOLO	CODICE	CAPACITÀ	□	□	L	RISOL.		
811 LBE 50	U08115026	10÷50 Nm	3/8"	9x12 mm	407 mm	1 Nm	384,00€	268,00 €
811 LBE 100B	U08115027	20÷100 Nm	3/8"	9x12 mm	487 mm	1 Nm	429,00€	300,00 €
811 LBE 100C	U08115028	20÷100 Nm	1/2"	9x12 mm	487 mm	1 Nm	431,00€	302,00 €
811 LBE 200	U08115029	40÷200 Nm	1/2"	14x18 mm	565 mm	1 Nm	450,00€	315,00 €
811 LBE 350	U08115032	70÷350 Nm	1/2"	14x18 mm	775 mm	2 Nm	510,00€	357,00 €

Serraggio controllato

**SERRAGGI
DESTROSI**



PRECISIONE
±4%

1/4"

**SERRAGGI
DESTROSI
E SINISTRORSI**



Cricchetto
amovibile

PRECISIONE
±4%

1/4"

**SERRAGGI
DESTROSI
E SINISTRORSI**



PRECISIONE
±4%

3/4"



810 N

ISO 6789

Chiave dinamometrica con cricchetto reversibile

- Meccanismo a scatto con molla di compressione.
- Riarmo automatico: dopo lo scatto è subito pronta all'uso.
- Fornita con certificato di collaudo.

ARTICOLO	CODICE	CAPACITÀ	☑	L	RISOL.		
810 N 5	U08104000	1÷5 Nm	1/4"	197 mm	0,05	243,00 €	159,00 €
810 N 25	U08104001	5 ÷ 25 Nm	1/4"	290 mm	0,05	243,00 €	159,00 €

811 NE

ISO 6789

Chiave dinamometrica con cricchetto reversibile amovibile

- Cricchetto amovibile e sostituibile con gli inserti della gamma 811.
- Meccanismo a scatto con molla di compressione.
- Riarmo automatico: dopo lo scatto è subito pronta all'uso.
- Fornita con certificato di collaudo.

ART.	CODICE	CAPACITÀ	☑	○	L	RISOL.		
811 NE 5	U08114009	1÷5 Nm	1/4"	9x12 mm	185 mm	0,05	282,00 €	197,00 €
811 NE 25	U08114010	5÷25 Nm	1/4"	9x12 mm	300 mm	0,05	288,00 €	201,00 €

812 N

ISO 6789

Chiavi dinamometriche con cricchetto reversibile

- Modelli a coppia regolabile per serraggi destrorsi e sinistrorsi con rotazione del cricchetto di 180°.
- Precisione ±4% del valore di coppia impostato.
- Scala di lettura in Nm.
- Meccanismo a scatto con molla di compressione.
- Riarmo automatico: dopo lo scatto è subito pronta all'uso.
- Blocco di sicurezza dopo la regolazione della coppia.
- Fornita in cassetta completa di certificato di collaudo.

ARTICOLO	CODICE	CAPACITÀ	☑	○			
812 N 600	U08120006	120 ÷ 600 Nm	3/4"	14x18 mm		1.119,00 €	783,00 €
812 N 1000	U08120010	200 ÷ 1000 Nm	3/4"	-		1.400,00 €	980,00 €

828 A

U08281500

Moltiplicatore di coppia

~~800,00 €~~ **560,00 €**

1/2"

Rapporto di moltiplicazione

1:6,5

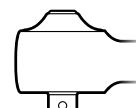

**CAPACITÀ
1500
Nm**

3/4"

Rapporto di trasmissione

1:9

828 B

U08282500

Moltiplicatore di coppia

~~1.100,00 €~~ **770,00 €**

1/2"

Rapporto di moltiplicazione

1:12

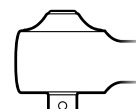

**CAPACITÀ
2500
Nm**

1"

Rapporto di trasmissione

1:16



▶ YouTube



889 RL

U08890036

Lampada di ispezione a LED

~~88,00 €~~

61,50 €



▶ YouTube



Base magnetica con morsetto e gancio

889 IL

U08890046

Lampada di ispezione articolata a LED

~~88,00 €~~

61,50 €

FLESSIBILE



MAX 250 LUMEN

MAX 250 LUMEN

889 CM

U08890048

Lampada di ispezione a LED flessibile

~~57,50 €~~

40,00 €



SENSORE DI MOVIMENTO



▶ YouTube

889 GR

U08890044

Faretto compatto a LED

~~118,00 €~~

82,00 €



889 RP

U08890045

Lampada a LED ricaricabile compatta

~~72,00 €~~

50,00 €



889 SP

U08890055

Torcia tascabile a LED

~~44,90 €~~

31,00 €

FORBICE 207 E

CON STRUTTURA INTEGRALE IN ACCIAIO INOX.



YouTube



L'UNICA CON STRUTTURA INTEGRALE IN ACCIAIO INOX
resiste alla flessione fino a 180 kg.



207 E
U02070006

Forbice professionale per elettricisti

44,90 €

31,00 €

SPELLAFILI INTEGRATO



1. Spellatura.
2. Crimpatura.

TAGLIACAVI SU ENTRAMBE LE LAME



Adatto per cavi multipolari.

LAMA MICRODENTATA ANTISCIVOLO



FORBICE 207 D

IL RIFERIMENTO PER GLI ELETTRICISTI.



IMPUGNATURA RESISTENTE ALLA FLESSIONE FINO A 80 kg
in tecnopolimero caricato vetro.

ASOLE MAGGIORATE



207 D
U02070008

Forbice professionale per elettricisti

27,80 €

19,50 €



50 mm²



LAME FLUIDE E ROBUSTE
In acciaio inox con microdentatura e tagliacavi.



YouTube



MAX
600 V

TRUE
RMS

MAX
600 V

TRUE
RMS



076 MC

U00760008



Pinza amperometrica con multimetro digitale TRUE RMS

- Parametri rilevabili: tensione e corrente AC/DC, resistenza, continuità, prova del diodo, temperatura, capacità, ciclo del lavoro e frequenza.

CARATTERISTICHE TECNICHE

V ~	0÷600 V
V ---	0÷600 V
Ω	0 ÷ 60M
→	SI
•	SI
Hz	Frequenza: 1 Hz÷9,99 MHz
A ~	0÷600 A
A ---	0÷600 A
%	5%÷95%



CAT III 600V

~~175,00 €~~
122,00 €

076 M

U00760007



Multimetro digitale con lettura a valore efficace TRUE RMS

- Parametri rilevabili: tensione e corrente AC/DC, resistenza, continuità, prova del diodo, capacità, frequenza, ciclo di lavoro, temperatura, DWELL, regime del motore, ampiezza d'impulso.

CARATTERISTICHE TECNICHE

V	6 ÷ 600V
V	600mV ÷ 600V
Ω	600 ÷ 60M
Hz	Frequenza: 9,999 Hz ÷ 9,999 MHz
A	60mA ÷ 10A
A	60mA ÷ 10A
°C	-20°C ÷ 1.000°C
DWELL	90° (4 cil) ÷ 45° (8 cil)
RPM	60 ÷ 20.000 giri/min
↘---	Protezione sovraccarico 600 V



CAT III 600V

~~146,00 €~~
102,00 €



Ø 4÷28 mm²



YouTube



163

U01630001

Sguainacavi multifunzione

- Per il taglio circolare e longitudinale di cavi con rivestimento esterno in PVC.
- Sistema a grilletto (-30% di sforzo): forza necessaria 75 N.
- Rotella di avanzamento della lama.
- Lama di spellatura auto rotante.
- Blocco grilletto con lama estratta.
- Blocco di sicurezza della lama.
- Corpo ergonomico in materiale plastico.
- Lama di ricambio inclusa.
- Kit lame di ricambio codice U01630002Q.

~~43,90 €~~

30,70 €

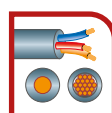

0,02÷10 mm²



146 A

U01460003

Pinza spellafili automatica diritta

- Funzioni di taglio e spellatura dei fili elettrici.
- Capacità 0,02-10 mm²/AWG 34-80.
- Ganasce intercambiabili senza uso di utensili.
- Tagliafili integrato nel corpo dell'utensile.
- Regolazione precisa del diametro di spellatura per evitare il danneggiamento dei conduttori.
- Lunghezza di spellatura regolabile.
- Dopo ogni singola spellatura, la ganasca si apre automaticamente per facilitare l'estrazione del filo.
- Impugnature ergonomiche bimatériauale.

~~109,00 €~~

76,00 €



211 A
U02110001

Forbice multiuso

- Lama con microdentatura antiscivolo.
- Leva per la selezione di mani piccole/grandi.
- Leva di sicurezza per il bloccaggio delle lame.
- Impugnature ergonomiche bimalteriali antiscivolo.



~~24,60 €~~ **17,20 €**



LAME IN ACCIAIO INOX

210 C
U02100003

Forbice multiuso

- Lama microdentata antiscivolo in acciaio inox.
- Grandi impugnature ergonomiche in bimalteriale.
- Perfetta per il taglio di alluminio, cartone, gomma, cuoio, moquette, ecc.

ADATTA PER DESTRIMANI

~~21,60 €~~ **15,10 €**



200 S
U02000002

Seghetto

- Anima in acciaio rivestita in materiale plastico antiscivolo ed antiurto.
- Fornito con lama al cobalto mod. 200 C24.

~~37,70 €~~ **26,40 €**



Novità

056 A
U00560003

Specchietto telescopico snodato a LED

- Specchio in vetro resistente alle rigature.
- Bordo paraurti in materiale plastico.
- LED per evitare di creare ombre sulla zona da osservare.

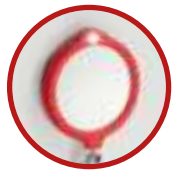

Ø SPECCHIO 55 mm

~~40,00 €~~ **28,00 €**



-20% DI SFORZO COMPATTA E POTENTE

ALLUMINIO E ACCIAIO

995 LA
U09950004

Rivettatrice dritta compatta

- Capacità: Ø 2,4 - 3,2 - 4 - 4,8 - 6,4 mm (3/32 - 1/8 - 5/32 - 3,16 - 1/4").
- Modello compatto con la stessa capacità di una rivettatrice lunga standard.
- Il sistema di leve interno riduce lo sforzo dell'operatore.
- Adatta a rivetti in alluminio ed acciaio
- 5 testine intercambiabili.
- Serbatoio amovibile per recupero steli.
- Corpo in lega leggera.

~~66,00 €~~ **46,20 €**

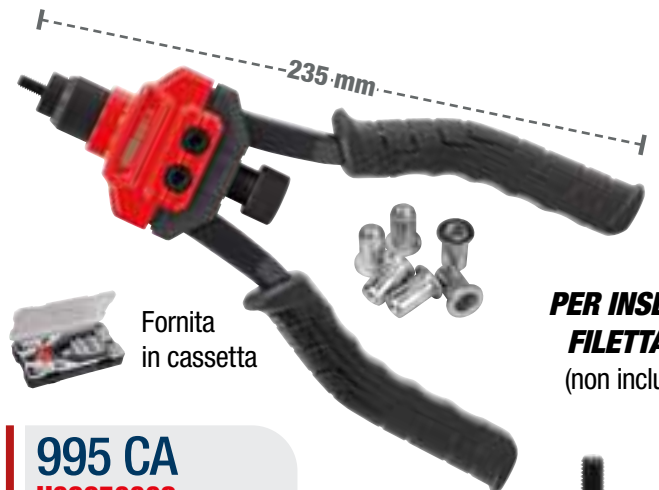

Fornita in cassetta

PER INSERTI FILETTATI (non inclusi)

995 CA
U09950008

Rivettatrice per inserti filettati

- Modello compatto con sistema di leve interno che garantisce meno sforzo all'operatore durante l'utilizzo.
- Fornita con 4 tiranti intercambiabili (M4-M5-M6-M8).
- Utilizzabile con rivetti in alluminio e acciaio (M4-M5-M6-M8) e acciaio inox (M4-M5).
- Corpo in lega leggera.



Ø M4 - M5 M6 - M8

~~95,00 €~~ **66,50 €**

DIN 338

HSS-G

14
PEZZI



988 LA/S14

U09880070

Assortimento di punte e maschi

- Ø punte: 2,5-3,3-4,2-5,0-6,8-8,5-10,2 mm.
- M maschi: 3x0,5-4x0,7-5x0,8-6x1-8x1,25-10x1,5-12x1,75 mm.

~~92,50 €~~

65,00 €

DIN 338

HSS-G

19
PEZZI



988 MA/S19

U09880073

Assortimento di punte

- Ø punte: 1,0-1,5-2,0-2,5-3,0-3,5-4,0-4,5-5,0-5,5-6,0-6,5-7,0-7,5-8,0-8,5-9,0-9,5-10,0 mm.

~~56,00 €~~

39,20 €

DIN 338

HSS-G

25
PEZZI



988 MA/S25

U09880074

Assortimento di punte

- Ø punte: 1,0-1,5-2,0-2,5-3,0-3,5-4,0-4,5-5,0-5,5-6,0-6,5-7,0-7,5-8,0-8,5-9,0-9,5-10,0-10,5-11,0-11,5-12,0-12,5-13,0 mm.

~~111,00 €~~

77,50 €



HSS

3
PEZZI



988 D/S3

U09880020

Serie di 3 frese a scalino

ART.	Ø SCALINI	Ø CODOLO	LUNG.
988 D1	4-5-6-7-8-9-10-11-12 mm	6 mm	65 mm
988 D2	4-6-8-10-12-14-16-18-20 mm	8 mm	75 mm
988 D3	4-6-8-10-12-14-16-18-20-22-24-26-28-30 mm	10 mm	100 mm

~~206,00 €~~

144,00 €

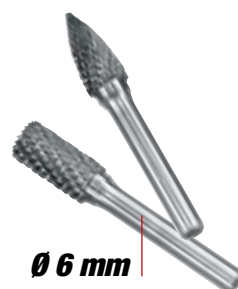

Ø 6 mm

HSS

10
PEZZI



988 G/S12

U09880100

Serie di 10 seghe a tazza bimetalliche

- Ø 19-22-25-29-35-38-44-51-57-64 mm.
- Profondità di taglio max: 38 mm.

~~212,00 €~~

148,00 €

988 E/S10

U09880062

Frese rotative in metallo duro

- N°8 pezzi (Ø 10 e 12 forme EA-EC-EF-EG).
- N°2 pezzi (Ø 12 forme ED-EM).

~~521,00 €~~

239,00 €



MAZZUOLE ANTIRIMBALZO

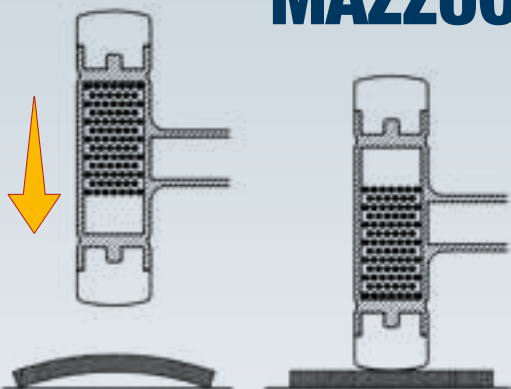

Nelle mazzuole antirimbalo, la testa è parzialmente riempita con sfere d'acciaio. Ad ogni colpo permettono l'assorbimento del rimbalo e conferiscono un perfetto bilanciamento.



CORPO IN ACCIAIO
con tasselli intercambiabili in materiale plastico.

374 N

Mazzuole antirimbalo

- Modello a tasselli intercambiabili in materiale plastico.
- Testa parzialmente riempita con graniglia metallica per l'assorbimento del rimbalo.
- Corpo in acciaio al carbonio.

CODICE	Ø TASSELLI	LUNGHEZZA		
U03740004	35 mm	310 mm	45,50 €	31,80 €
U03740005	40 mm	315 mm	51,00 €	35,70 €
U03740006	50 mm	325 mm	61,50 €	43,00 €
U03740007	60 mm	335 mm	72,00 €	50,50 €



MONOBLOCCO
testa e manico sono un corpo unico.

374 G

Mazzuola antirimbalo monoblocco

- Mazzuola antirimbalo con microsferi d'acciaio.
- Corpo e manico in acciaio sovrastampato in poliuretano.
- Superficie di percussione di durezza shore D45 ± 5.
- Impugnatura PVC ergonomica.

CODICE	Ø TASSELLI	LUNGHEZZA		
U03740040	40 mm	298 mm	51,50 €	36,00 €
U03740050	50 mm	308 mm	63,50 €	44,40 €
U03740060	60 mm	316 mm	72,00 €	50,50 €



2-3-4-5-6-8 mm

367 A SE6

U03670115

6
PEZZI

Serie di 6 cacciaspine con impugnatura

- 367/2x140-3x150-4x195-5x205-6x210-8x220 mm.
- Fornita in busta in tessuto ad altissima resistenza.
- Acciaio al cromo vanadio.
- Punta con durezza 58 HRC.
- Battuta con durezza 43 HRC.

~~74,50 €~~

51,00 €



CORPO IN ACCIAIO
con tasselli intercambiabili
in materiale plastico.

376

UNI 7784

Mazzuole

- Modello a tasselli intercambiabili in materiale plastico.
- Corpo in acciaio al carbonio.
- Manico in frassino.

CODICE	Ø TASSELLI	LUNGHEZZA	PREZZO	PREZZO
U03760001	22 mm	250 mm	15,50 €	11,00 €
U03760002	28 mm	275 mm	18,90 €	13,00 €
U03760003	35 mm	300 mm	23,80 €	16,70 €
U03760004	42 mm	325 mm	32,10 €	22,50 €
U03760005	50 mm	350 mm	44,10 €	30,90 €
U03760006	60 mm	380 mm	61,50 €	43,00 €



Testa in acciaio al carbonio forgiata e sottoposta a trattamento termico differenziato per garantire una maggiore durata ed evitare scheggiature o ricalcature della superficie battente.

Protezione del manico sotto la testa

382

UNI 7777 DIN 6475

Martelli per meccanici

- Modello tedesco a testa quadra piana e penna simmetrica.
- Manico in frassino.

CODICE	PESO TESTA	LUNGHEZZA	PREZZO	PREZZO
U03820002	100 g	260 mm	12,10 €	8,45 €
U03820004	200 g	280 mm	12,60 €	8,80 €
U03820006	300 g	300 mm	13,90 €	9,75 €
U03820007	400 g	310 mm	16,50 €	11,50 €
U03820008	500 g	320 mm	18,50 €	12,90 €
U03820009	600 g	330 mm	21,40 €	15,00 €
U03820010	800 g	350 mm	24,80 €	17,40 €
U03820011	1000 g	360 mm	27,90 €	19,50 €
U03820013	1500 g	380 mm	37,40 €	26,20 €
U03820014	2000 g	400 mm	48,40 €	33,90 €

2-3-4-5-6-8 mm



367 SE6

U03670081

6
PEZZI

Serie di 6 cacciaspine

- 367/2x115-3x125-4x145-5x165-6x180-8x200 mm.
- Fornita in busta in tessuto ad altissima resistenza.
- Acciaio al cromo vanadio.
- Punte riportate e fosfatate per le misure da 2 e 3 mm.

~~57,00 €~~

39,90 €

Estrattori per viti spezzate

GAMMA 456: PER FILETTI SPEZZATI ESPOSTI

Martellabili e utilizzabili con avvitatori a impulsi

Novità



Inserisci



Estrai



Sistema di rimozione brevettato



PROFILO SPECIALE



MASSIMA VERSATILITÀ

Oltre a estrarre viti spezzate, questo estrattore offre il vantaggio di adattarsi facilmente a componenti di qualsiasi forma, come tonda, quadrata o esagonale.



GAMMA 457: PER FILETTI SPEZZATI INCASSATI

Novità



PROFILO SPECIALE



Fora



Inserisci



Estrai



Sistema di rimozione brevettato



Novità

7 PEZZI



457 S7
U04570010



Assortimento di estrattori per viti o filetti incassati spezzati

278,00 €

189,00 €

Estrattori per viti spezzate

Novità



9 PEZZI $\frac{1}{4}$ "

 4-5-6-7-8-9-10-11-12 mm
 M3,5-M6

456 S9 1/4"
U04560101

 600 g  mm  210
 130

Assortimento di estrattori a bussola macchina con profilo speciale

~~197,00 €~~ **137,00 €**

Novità



6 PEZZI $\frac{3}{8}$ "

 13-14-15-16-17-18 mm
 M9

456 S6 3/8"
U04560102

 962 g  mm  210
 130

Assortimento di estrattori a bussola macchina con profilo speciale

~~189,00 €~~ **137,00 €**

Novità



7 PEZZI $\frac{1}{2}$ "

 19-20-21-22-23-24-25 mm
 M12

456 S7 1/2"
U04560103

 2,36 kg  mm  330
 215

Assortimento di estrattori a bussola macchina con profilo speciale

~~323,00 €~~ **232,00 €**

22 PEZZI

Novità



456 S22
U04560104

 3,8 kg  mm  435
 270

Assortimento di estrattori a bussola macchina con profilo speciale

~~698,00 €~~ **489,00 €**

$\frac{1}{4}$ "  4-5-6-7-8-9-10-11-12 mm

$\frac{3}{8}$ "  13-14-15-16-17-18 mm

$\frac{1}{2}$ "  19-20-21-22-23-24-25 mm

 M3,5-M6-
M9-M12

ESTRATTORI PER CUSCINETTI



Novità



Per cuscinetti a sfera ISO:

6004 ÷ 6010;
6200 ÷ 6205;
6300 ÷ 6302.

Ø da 25 a 95 mm



474 S1

U04740001

4
PEZZI

Assortimento in cassetta di ABS con estrattori per cuscinetti

~~105,00 €~~

73,50 €



Novità



Per cuscinetti a sfera ISO:

6206 ÷ 6211;
6303 ÷ 6307;
6403 ÷ 6404.

Ø da 40 a 110 mm

474 S2

U04740002

4
PEZZI



Assortimento in cassetta di ABS con estrattori per cuscinetti

~~247,00 €~~

173,00 €



Novità



Per componenti meccanici con

Ø interno 6,5÷18 mm

468 NK1

U04680104

5
PEZZI



Assortimento in cassetta di ABS con estrattori ad espansione

ART.	DESCRIZIONE	PZ.
468 C	Estrattori ad espansione per interni 1-2-3-4	4
468 ED	Estrattore a percussione	1

~~394,00 €~~

276,00 €



Novità



Per componenti meccanici con

Ø interno 18÷50 mm

468 NK2

U04680105

5
PEZZI



Assortimento in cassetta di ABS con estrattori ad espansione

ART.	DESCRIZIONE	PZ.
468 C	Estrattori ad espansione per interni 5-6-7-8	4
468 E1	Estrattore a percussione	1

~~623,00 €~~

436,00 €



Novità



Per componenti meccanici con

Ø interno 8,5÷38 mm

468 NK3

U04680106

9
PEZZI



Assortimento in cassetta di ABS con estrattori ad espansione

ART.	DESCRIZIONE	PZ.
468 C	Estrattori ad espansione per interni 2-3-4-5-6-7	6
468 D1-3	Supporti per estrattori a percussione	2
468 F1	Adattatore per estrattori 468 D2 - D3 - E2	1

~~912,00 €~~

638,00 €



454

Estrattori a due bracci per esterni

CODICE	A	B	POTENZA	🔸		
U04540000	65 mm	70 mm	1,5 t	13 mm	85,50 €	60,00 €
U04540010	90 mm	110 mm	3 t	17 mm	96,50 €	67,50 €
U04540020	130 mm	110 mm	3 t	17 mm	104,00 €	73,00 €
U04540030	175 mm	165 mm	4 t	17 mm	168,00 €	118,00 €
U04540040	220 mm	165 mm	4 t	17 mm	185,00 €	130,00 €
U04540050	270 mm	220 mm	5 t	21 mm	260,00 €	182,00 €
U04540060	340 mm	220 mm	5 t	21 mm	290,00 €	203,00 €



Novità



8÷24 mm

490 S2

U04900010

2
PEZZI

Assortimento in cassetta di ABS con spaccadadi

86,40 €

61,00 €

COMPRESSE NEL PREZZO



4
PEZZI



451 N/S4

U04510100

Estrattore a tre bracci per esterni

- Modello a bracci autoserranti.
- Capacità: 7÷140 mm.
- Potenza: 3 ton.
- Spina di sicurezza.
- Vite di manovra con esagono da 18 mm.
- Possibilità di utilizzo a due bracci.
- Viti di manovra M16x2.

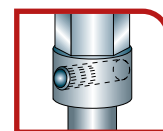

Spina di sicurezza:
utilizzo sicuro e qualità
dell'attrezzo preservata

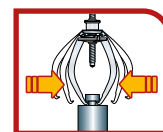

Autoserrante
Autocentrante

355,00 €

180,00 €



Novità

M12 - M10 - M8



22 mm



459/1 S3

U04590182

3
PEZZI

Serie di estrattori a rulli per viti prigioniere

103,00 €

72,00 €

TRASFORMATORE INTEGRATO

Nessun alimentatore esterno.



YouTube

12 V **1200 A**

10 kg | 400 mm | 320 mm | 115 mm



CONNETTORE POSTERIORE PER SELEZIONE VOLTAGGIO

12 V **1400 A**
24 V **700 A**

20,8 kg | 560 mm | 590 mm | 200 mm



12V - 3700A

24V - 1860A

1613 RA12

U16130019

Avviatore portatile 12V

- Scocca antiurto in ABS.
- Idoneo anche per batterie sigillate.

~~613,00 €~~

429,00 €

3500A

Lunghezza cavi
155 cm

1613 AGM12-24

U16130013

Avviatore professionale portatile 12V-24V

- Scocca antiurto in ABS.
- Protezione da sovratensione.

~~1.388,00 €~~

972,00 €

Lunghezza cavi
155 cm



YouTube

POTENZA DI COMPRESSIONE

735 kg (6 bar), 1226 kg (10 bar).

447 T

U04470101

Smonta ammortizzatori pneumatico

- Ideale per autovetture.
- Fornito con due staffe inferiori 447 TC1 (78÷130 mm) e 447 TC2 (105÷182 mm), morsa 447 TA e morsetti superiori universali 447 TB1.

CARATTERISTICHE TECNICHE

Potenza compressione 735 kg (6 bar) - 1226 kg (10 bar)

Pressione di esercizio 6÷10 bar

Corsa del pistone 420 mm

Cilindro Doppio in lega d'alluminio e resina al nylon

60 kg | 470 mm | 1.390 mm | 450 mm



Pressione regolabile FINO A 4 BAR

12 V

10 Litri

2847/3

U28470084

Spurgatore per circuito freni

- Permette di cambiare, riempire, spurgare i circuiti dei freni di autovetture e vecchi industriali.
- Apparecchio progettato esclusivamente per liquidi freno tipo DOT 3, DOT 4, DOT 5.1. No LHM.

CARATTERISTICHE TECNICHE

Sistema di manovra del liquido Pompa peristaltica (nessun contatto diretto pompa liquido, nessuna pressione aria sul liquido)

Alimentazione 12 V (morsetti batteria)

Capacità serbatoio 10 litri

Limitatore di pressione 4 bar

Tubo a spirale 4 m (elastico)

Cavo di alimentazione 4 m



Fornito con:

- guarnizioni di ricambio,
- 1 tappo multidiametro 44-45-46 mm (2847 N11).
- 1 contenitore di recupero olio.

~~2.135,00 €~~

1.495,00 €

~~1.685,00 €~~

1.180,00 €

890 N
U08900002



Tester batterie 12V

- Consente di testare lo stato di salute della batteria, del sistema di avviamento e del sistema di carica.
- Utilizzabile batterie 12V, con capacità 100-2000 CCA, BCI, CA, MCA, IT, SAE; 100-1400 DIN, IEC; JIS 26A17-245H2.
- Permette di testare batterie di tipo standard (Piomboacido), GEL, EFB, AGM piatta, AGM Spirale, Litio.
- Schermo retroilluminato.
- Lunghezza cavi (morsetti compresi): 94 cm.
- Protezione contro l'inversione di polarità.
- 8 lingue selezionabili: italiano, inglese, tedesco, francese, olandese, russo, spagnolo e portoghese.
- È possibile testare la batteria sia a bordo che fuori dal veicolo.
- Il tester fornisce risultati precisi al 99,5%.

~~71,00 €~~

49,70 €



**TEST BATTERIE
TEST RICARICA
TEST AVVIAMENTO**

**Lunghezza cavi
94 cm**



**IDEALE PER IMMETTERE
OLIO NEL DIFFERENZIALE**

**Non adatta per carburanti
e olii minerali**

**1,5
Litri**



**IDEALE PER ASPIRAZIONE ED
EROGAZIONE DI OLIO, LIQUIDO
ANTIGELO E OLIO SERVOSTERZO**



421 M
U04210021

Siringa in metallo

~~29,50 €~~

20,60 €

**3
Litri**

**IDEALE PER SPURGO DEL
LIQUIDO DEI FRENI O FRIZIONE**

Pressione
di utilizzo
6÷10 bar



2847 A
U28470086

Spurgatore a depressione

~~105,00 €~~

73,50 €

**9,5
Litri**



1785 B
U17850005

Aspiratore liquidi
manuale e pneumatico

~~243,00 €~~

170,00 €





30,5 kg
mm → 615
↗ 344

2550 A U25500001

3 TON 30,5 kg

CE
3t

Sollevatore idraulico 3T per auto e veicoli commerciali

- Struttura in acciaio.
- Portata elevata per utilizzo su auto, fuoristrada e furgoni.
- Sistema a doppia pompa per sollevare più velocemente la vettura.
- Dotato di comando di discesa manuale.
- Valvola di spurgo dell'aria, per evitare il pericolo di over-carico.

~~365,00 €~~ **245,00 €**



32,5 kg
mm → 762
↗ 350

2550 B U25500002

2 TON 32,5 kg

CE
2t

Sollevatore idraulico 2T

- Struttura in acciaio.
- Per utilizzo in spazi ridotti.
- Sistema a doppia pompa per sollevare più velocemente la vettura.
- Dotato di pedale di avvicinamento.
- Dotato di comando di discesa manuale.
- Valvola di spurgo dell'aria, per evitare il pericolo di over-carico.

~~515,00 €~~ **360,00 €**



1950 C

2 PEZZI

Coppia colonnette

- Altezza regolabile tramite meccanismo dentato con rilascio a leva.
- Perno di bloccaggio con catena.
- 1950 C/3: modello regolabile a 10 posizioni.
- 1950 C/6: modello regolabile a 13 posizioni.



CODICE PORT. H MAX H MIN DIMENSIONI PESO

U19501001 3t 427 mm 300 mm 207x188 mm 7 kg ~~101,00 €~~ **70,50 €**

U19501002 6t 620 mm 400 mm 285x250 mm 14 kg ~~146,00 €~~ **102,00 €**



4,6 kg
mm → 1.030
↗ 480
↘ 115

2000 A U20000100

Lettino sottoscocca 6 ruote

- Cuscino poggiatesta in vinile resistente agli idrocarburi.
- Struttura in materiale plastico resistente agli idrocarburi, lavabile.

~~130,00 €~~ **91,00 €**



YouTube
**VIDEO
TUTORIAL**



**10
PEZZI**

KIT UNIVERSALE PER LA RIMOZIONE DI DADI E VITI ANTIFURTO

272 DS
U02720001



Kit estrazione dadi e viti antifurto

- Non danneggia il cerchio in lega.
- Punte speciali al carburo di tungsteno in grado di forare qualsiasi tipo di materiale (lubrificare con olio da taglio ad ogni utilizzo).
- Bussole coniche per centraggio/estrazione super sottili per accedere su ogni tipo di cerchio in lega.

~~311,00 €~~

210,00 €

BUSSOLE MACCHINA RINFORZATE 270



ANELLO IN ACCIAIO PRESSOFUSO

Garantisce una resistenza 4 volte superiore rispetto alle bussole standard per dadi ruote.



RIVESTIMENTO PROTETTIVO IN TEFLON

Riduce il rischio di danneggiamento quando si opera su cerchi in lega di alluminio.



1/4"



**3
PEZZI**

1/4"

270

Chiavi a bussola macchina rinforzate per cerchi in lega con protezione in teflon

CODICE	Ø	L	Ø	13,40 €	9,40 €
U02701017	17 mm	85 mm	26 mm	13,40 €	9,40 €
U02701019	19 mm	85 mm	28 mm	13,40 €	9,40 €
U02701021	21 mm	85 mm	30 mm	13,40 €	9,40 €

270 C3
U02700160



Assortimento in cassetta modulare con bussole macchina per cerchi in lega con protezione in teflon

~~42,40 €~~

29,70 €

CHIAVE FILTRI OLIO 443 N CON REGOLAZIONE AUTOMATICA DEL NASTRO.

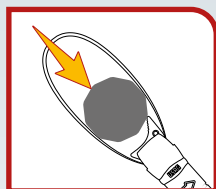

**SERRAGGIO AUTOMATICO
DEL NASTRO**

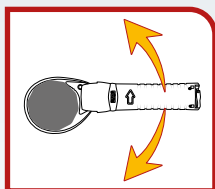

EFFETTO CRICCHETTO
Rapidità d'uso anche in
spazi ridotti.

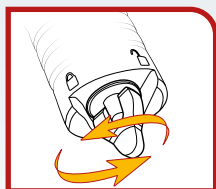

**LEVA DI INCREMENTO
POTENZA SERRAGGIO**



**66÷105
mm**

**443 N
U04430005**

**Chiave automatica a
ripresa rapida per filtri
olio (autovetture)**

~~108,00 €~~ **67,00 €**



YouTube

**6
PEZZI**

**3
8"**



Permettono il riserraggio alla coppia
originale di smontaggio (valore indicato
sulla campana di plastica)

**446 DA/SE6
U04461104**

Serie di 6 chiavi per coperchio filtro olio

- 1 chiave 14 tacche Ø 76 mm.
- 1 chiave 14 tacche Ø 102 mm.
- 1 chiave 16 tacche Ø 76 mm.
- 1 chiave 16 tacche Ø 88 mm.
- 1 chiave 18 tacche Ø 66 mm.
- 1 chiave 18 tacche Ø 96 mm.
- Quadro di manovra 3/8".

~~226,00 €~~ **158,00 €**



Inquadra il QR code per
scaricare la tabella delle
applicazioni o vai su usag.it

**3
8"**

**1
4"**

**30
PEZZI**

7 kg 620 mm 70 mm 500

**446 S28
U04461204**

Assortimento di 30 chiavi per filtri olio

- Misure delle 28 chiavi a tazza Ø x N°lati:
66/6 - 65/14 - 65/67 - 68/14 - 73/14 - 74/15 -
74/76 - 75/77 - 76/12 - 76/14 - 76/30 - 76/8
- 78/15 - 80/15 - 80/82 - 86/16 - 86/18 -
90/15 - 92/10 - 93/15 - 93/36 - 93/45 - 95/15
- 96/18 - 100/15 - 106/15 - 108/15 - 108/18.

~~214,00 €~~ **150,00 €**



Inquadra il QR code per scaricare la tabella delle applicazioni o vai su usag.it



IN ALLUMINIO

446 DT/S2

U04461203

Serie di 2 chiavi per coperchi filtro olio modelli giapponesi

- Riduce i rischi di danneggiamento dei coperchi filtri.
- Utilizzabili anche in serraggio con chiave dinamometrica.



2
PEZZI

~~63,50 €~~

44,40 €

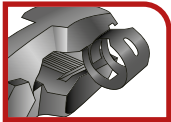

2 in 1

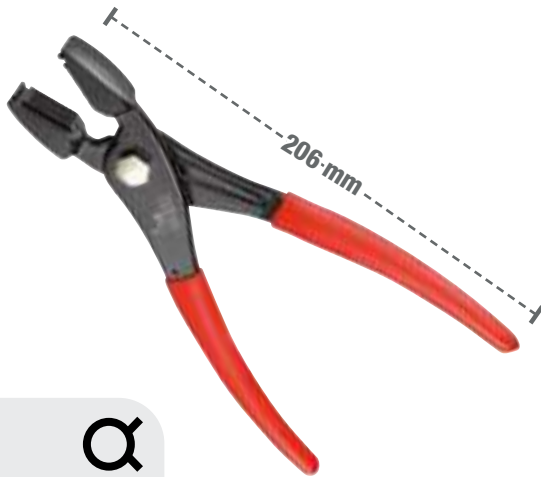

871 D

U08710001



Pinza per anelli stringitubo a presa frontale/laterale

- Possibilità di aggancio frontale o laterale.
- Ganasce con superficie di presa zigrinata.

~~57,00 €~~

39,90 €

3 posizioni di lavoro

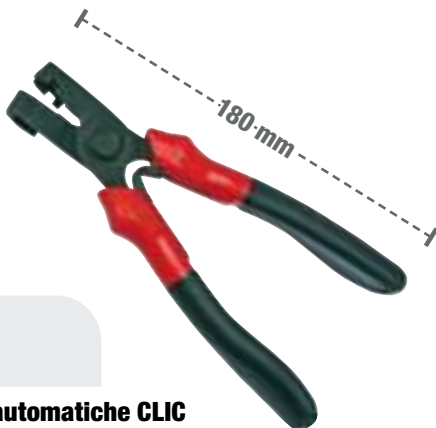

871 C

U08719005P

Pinza per fascette automatiche CLIC

- Testa triassiale per lavorare in tutte le posizioni.
- Permette di aprire o chiudere le fascette automatiche presenti sui circuiti del carburante, dei collettori d'aspirazione e dei circuiti idraulici.

~~81,50 €~~

57,00 €

16
PEZZI

3/8

263/S16

U02631400

Kit per tappi olio

- Bussole magnetiche.
- 1 chiave snodata con coppetta.
- 2 inserti \bigcirc 8-10 mm.
- 6 inserti \bigcirc 8-10-12-13-14-17 mm.
- 6 bussole \blacklozenge 13-14-17-18-19-21 mm.
- 1 inserto \bigcirc T45.

~~202,00 €~~

141,00 €

Attacco per il recuperatore d'olio



Vaschetta raccogli olio integrata



870 C

U08700006

Pinza per raccordi rapidi carburante

- Per veicoli a benzina e diesel.
- Impugnature ergonomiche bimalteriali.

~~69,00 €~~

48,30 €



22
PEZZI

1881 S22

U18810082

Kit universale per lo smontaggio e il montaggio delle ghiera pulegge alternatori

- Fornito in cassetta di plastica

~~146,00 €~~

102,00 €





2 MODALITÀ:

- 1 250 l/min - 50°÷400°C
- 2 500 l/min - 50°÷600°C

MAX
600
GRADI

2000
WATT



Accessori inclusi

391

U03910001

Pistola termica digitale

- Modello elettronico con controllo della temperatura e del volume d'aria mediante display digitale.
- Possibilità di impostazione dei programmi.
- Dotata di sistema di raffreddamento.

~~220,00 €~~

95,00 €

5
PEZZI

Per la rimozione di modanature, pioli, parti di cruscotto, rivestimenti portiere, etc.



426 B/S5

U04260006

Kit di 5 utensili per componenti in plastica

~~33,70 €~~

23,60 €

4
PEZZI

Per separare i carter della cinghia di distribuzione, testata motore, cinghia di trasmissione etc.



426 D/S4

U04260005

Kit di 4 scalpelli separatori in plastica

~~28,90 €~~

20,20 €



CARATTERISTICHE TECNICHE

Attacco filettatura	M18
Livello sonoro	78 Db
Lunghezza totale	610 mm
Peso	4 Kg
Pressione di esercizio	6,2 bar
Attacco filettato	1/4"

400 P

U04000010

Aspiratore pneumatico ammaccature

- Ideale per eliminare ammaccature da parti scatolate senza la necessità di rivernicare.
- Fornito con 3 ventose (Ø 75-100-125 mm), in valigetta in materiale plastico dotata di maniglia per il trasporto e clip di chiusura.

~~216,00 €~~

151,00 €

4
PEZZI

Per la rimozione di contrappesi, silicone, modanature etc



426 C/S4

U04260007

Kit di 4 raschietti multiuso in plastica

~~35,90 €~~

25,10 €

2
PEZZI

115 CL/SE2

U01150022

Serie di 2 pinze lunghe becchi diritti e piegati a 45°

- Ideale per la presa di pezzi e parti in posizioni di difficile accesso.

~~85,50 €~~

60,00 €



Serraggi controllati utilizzando cricchetti o chiavi a T

1/2"



YouTube

814 A

Dispositivo digitale coppia-angolo

- Permette serraggi coppia ed angolo di precisione digitale anche con utensili tradizionali.
- Per serraggi destrorsi e sinistrorsi.
- Scala di lettura in Nm/ft.lb/in.lb/kg.cm/gradi.
- Doppia indicazione: luminosa (LED) e sonora (buzzer) al raggiungimento del valore impostato.
- 9 valori di coppia o angolo preimpostabili.
- 50 misurazioni memorizzabili.
- In custodia di ABS con certificato di taratura.
- Alimentazione: 2 batterie AAA (incluse).

CODICE	CAPACITÀ	1/2"	RISOL.		
U08140003	6,8÷135 Nm	1/2"	0,1	279,00 €	195,00 €
U08140004	10÷200 Nm	1/2"	0,1	321,00 €	225,00 €
U08140005	17÷340 Nm	1/2"	0,1	390,00 €	273,00 €

Misurazione corretta dell'angolo in qualsiasi posizione

PRECISIONE ±2%



YouTube

831 A

U08310001

Goniometro digitale

- Permette serraggi angolari di precisione digitale in totale semplicità.
- Per serraggi destrorsi e sinistrorsi.
- Precisione angolo: +/- 2%.
- Scala: 0÷360°.
- Risoluzione: 0,1°.
- Doppia indicazione: luminosa (LED) e sonora (buzzer) al raggiungimento del valore impostato.
- 9 valori di angolo preimpostabili.
- 50 misurazioni memorizzabili.
- Fornito in custodia di ABS con certificato di taratura.
- Alimentazione: 2 batterie AAA (incluse nella confezione).

~~203,00 €~~

133,00 €

9 PEZZI

Due spazzole metalliche Ø 20mm e 25mm



885 F

U08850004

Kit pulizia iniettori

- Ideale per la pulizia del condotto degli iniettori montati su motori common rail.

~~181,00 €~~

127,00 €

6 PEZZI

1/2"



884 C/S6

U08841000

Serie di 6 chiavi per raccordi tubi iniettori

- Per montaggio/smontaggio dei raccordi tubi iniettori.
- Lunghezza: 98 mm.
- Misure: 12-14-16-17-18-19 mm.

~~136,00 €~~

95,00 €

ARIA COMPRESSA

**Tubo 10 m
Ø 8 mm**



939 C U09390003

 3,9 kg	 mm	 355 185 310
--	--	---

Avvolgitubo aria 8 mm

Modello a recupero automatico del tubo con dispositivo d'arresto. Corpo in materiale plastico antiurto con staffa girevole per il fissaggio a parete. Utilizzabile anche in ambienti esterni. Tubo in poliuretano/PVC.

CARATTERISTICHE TECNICHE

Lunghezza tubo	10 m
Diametro interno tubo	8 mm
Pressione max di utilizzo	15 bar
Lunghezza tubo alimentazione	1,5 m
Raccordo in uscita	3/8"
Consumo medio aria l/min	300 l/min@7bar

2006/42/CE
ISO EN 12100:2010

~~175,00 €~~ **122,00 €**

ARIA COMPRESSA

**Tubo 16 m
Ø 10 mm**



939 C1 U09390004

 8 kg	 mm	 450 230 400
---	---	--

Avvolgitubo aria 10 mm

Modello a recupero automatico del tubo con dispositivo d'arresto. Corpo in materiale plastico antiurto con staffa girevole per il fissaggio a parete. Utilizzabile anche in ambienti esterni. Tubo in poliuretano/PVC.

CARATTERISTICHE TECNICHE

Lunghezza tubo	16 m
Diametro interno tubo	10 mm
Pressione max di utilizzo	15 bar
Lunghezza tubo alimentazione	1,5 m
Raccordo in uscita	3/8"
Consumo medio aria l/min	450 l/min@7bar

2006/42/CE
ISO EN 12100:2010

~~348,00 €~~ **185,00 €**

ARIA COMPRESSA

**Tubo 16 m
Ø 12,5 mm**



939 C2 U09390005

 10,6 kg	 mm	 550 270 505
---	--	---

Avvolgitubo aria 12,5 mm

Modello a recupero automatico del tubo con dispositivo d'arresto. Corpo in materiale plastico antiurto con staffa girevole per il fissaggio a parete. Utilizzabile anche in ambienti esterni. Tubo in poliuretano/PVC.

CARATTERISTICHE TECNICHE

Lunghezza tubo	16 m
Diametro interno tubo	12,5 mm
Pressione max di utilizzo	15 bar
Lunghezza tubo alimentazione	1,5 m
Raccordo in uscita	3/8"
Consumo medio aria l/min	800 l/min@7bar

2006/42/CE
ISO EN 12100:2010

~~440,00 €~~ **308,00 €**

ELETTRICITÀ 230V

**Cavo 15 m
3G x 1,5 mm²**



939 E
U09390007



Avvolgicavo

- Modello a recupero automatico del cavo con dispositivo d'arresto.
- Corpo in materiale plastico antiurto con staffa girevole per il fissaggio a parete.
- Cavo 3G x 1.5mm² in PVC.
- Presa e spina Schuko.
- Dispositivo di arresto del cavo a cremagliera inseribile ogni 50 cm.

CARATTERISTICHE TECNICHE

Lunghezza tubo	15 m
Portata cavo avvolto	1,2 KW @230V
Portata cavo svolto	1,5 KW @230V
Grado di protezione	IP 42

~~264,00 €~~

185,00 €

OLIO E ACQUA

**Tubo 15 m
Ø 10 mm**



939 W
U09390006



Avvolgitubo per olio e acqua

- Modello a recupero automatico del tubo con dispositivo d'arresto.
- Bobina in ABS e staffa in acciaio verniciata epossidicamente..
- Tubo in gomma sintetica rinforzato EN857 1 SC colore nero.
- Raccordo in entrata in ottone.

CARATTERISTICHE TECNICHE

Raccordo in entrata	3/8 F
Raccordo in uscita	3/8 F girevole
Diametro interno tubo	10 mm
Lunghezza tubo	15 m
Pressione massima	180 bar
Temperatura di esercizio	-15 ÷ 130 °C

~~602,00 €~~

421,00 €

**Nastro 20 m
Largh. 4 cm**



939 N
U09390008



Avvolgitore per delimitazione area

- Nastro a strisce bianche/rosse in polipropilene lunghezza 20 m.
- Per la creazione di barriere provvisorie e delimitazione di aree pericolose.
- Modello a recupero automatico del nastro con dispositivo d'arresto.
- Corpo in materiale plastico antiurto con staffa girevole per il fissaggio a parete.
- Staffa orientabile di 180°.

~~205,00 €~~

144,00 €



ILLUMINAZIONE A LED



YouTube



CARTER IN LEGA DI MAGNESIO



943 PC1 1/2" U09430001

Avvitatore ad impulsi in magnesio

CARATTERISTICHE TECNICHE

Attacco quadro	1/2"	Pressione aria raccomandata	6,2 bar
Capacità bullone	M20	Pressione sonora	94 ±3 dB(A)
Coppia massima	1.898 Nm	Potenza sonora	105 ±3 dB(A)
Coppia di lavoro	320÷460 Nm	Vibrazioni	6,4 m/s ²
Impulsi al minuto	1200	Attacco aria	1/4"
Velocità a vuoto	6.500 giri/min	Diametro interno tubo aria	10 mm
Consumo medio aria	172 l/min	Peso	2,2 kg

539,00 €

369,00 €



943 PC1/C12 U09430005



12
PEZZI

Assortimento in cassetta modulare con avvitatore ad impulsi e bussole macchina

717,00 €

449,00 €

10-13-17-18-
19-22-24-27-
30-32 mm

CARTER IN LEGA DI MAGNESIO



YouTube



929 PC1 1/2" U09290001

Avvitatore ad impulsi in magnesio

CARATTERISTICHE TECNICHE

Attacco quadro	1/2"	Pressione aria raccomandata	6,2 bar
Capacità bullone	M16	Pressione sonora	93 ±3 dB(A)
Coppia massima	1.600 Nm	Potenza sonora	104 ±3 dB(A)
Coppia di lavoro	280÷440 Nm	Vibrazioni	6,2 m/s ²
Impulsi al minuto	1.300	Attacco aria	1/4"
Velocità a vuoto	7.000 giri/min	Diametro interno tubo aria	10 mm
Consumo medio aria	172 l/min	Peso	2,0 kg

415,00 €

279,00 €



929 PC1/C12 U09290006

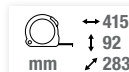

12
PEZZI

Assortimento in cassetta modulare con avvitatore ad impulsi e bussole macchina

593,00 €

365,00 €

10-13-17-18-
19-22-24-27-
30-32 mm



YouTube



11 cm



942 PC3 1/2"

U09420012

Avvitatore ad impulsi - extra compatto

CARATTERISTICHE TECNICHE

Attacco quadro	1/2"	Pressione aria raccomandata	6,2 bar
Capacità bullone	M16	Pressione sonora	91,1±3 dB(A)
Coppia massima	861 Nm	Potenza sonora	108,1±3 dB(A)
Coppia di lavoro	150÷220 Nm	Vibrazioni	9,57 m/s ²
Impulsi al minuto	1650	Attacco aria	1/4"
Velocità a vuoto	10.000 giri/min	Diametro interno tubo aria	10 mm
Consumo medio aria	127 l/min	Peso	1,3 kg

~~268,00 €~~

188,00 €



942 PC3/C7

U09420015

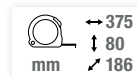

Assortimento in cassetta modulare con avvitatore ad impulsi e bussole macchina

DESCRIZIONE	ART./MISURA	PZ.
Avvitatore ad impulsi - extra compatto	942 PC3 1/2	1
Chiavi a bussola macchina con bocca esagonale	235 1/2 M/ 13-17-19-21-22-24 mm	6
Spina di tenuta	235 MCA/4	1
Anello di sicurezza	235 MDA/4	1

13-17-19-21-22-24 mm

~~356,00 €~~

243,00 €

ILLUMINAZIONE A LED

CARTER IN LEGA DI MAGNESIO

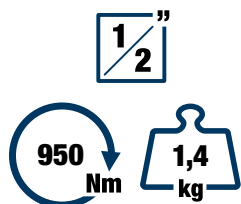

943 PC2 1/2"

U09430002

Avvitatore ad impulsi in magnesio con LED - Extra compatto

CARATTERISTICHE TECNICHE

Attacco quadro	1/2"	Pressione aria raccomandata	6,2 bar
Capacità bullone	M16	Pressione sonora	95±3 dB(A)
Coppia massima	950 Nm	Potenza sonora	107±3 dB(A)
Coppia di lavoro	200÷270 Nm	Vibrazioni	3,9 m/s ²
Impulsi al minuto	1400	Attacco aria	1/4"
Velocità a vuoto	10.000 giri/min	Diametro interno tubo aria	10 mm
Consumo medio aria	167 l/min	Peso	1,4 kg

~~459,00 €~~

321,00 €

CORPO IN ALLUMINIO

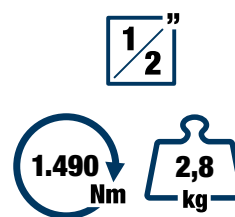

928 AC1 1/2"

U09280014

Avvitatore ad impulsi in alluminio

CARATTERISTICHE TECNICHE

Attacco quadro	1/2"	Pressione sonora	90 ±3 dB(A)
Capacità bullone	M16	Potenza sonora	101 ±3 dB(A)
Coppia massima	1.490 Nm	Vibrazioni	5,2 m/s ²
Coppia di lavoro	135÷380 Nm	Attacco aria	1/4"
Impulsi al minuto	1.120	Diametro interno tubo aria	10 mm
Velocità a vuoto	6.500 giri/min	Peso	2,8 kg
Consumo medio aria	147 l/min		
Pressione aria raccomandata	6,2 bar		

~~329,00 €~~

223,00 €

CARTER IN LEGA DI TITANIO

3/4"

2.115 Nm
3,8 kg



CORPO IN ALLUMINIO

3/4"

1.700 Nm
5,6 kg



942 PD1 3/4"

U09420004

Avvitatore ad impulsi in titanio

CARATTERISTICHE TECNICHE

Attacco quadro	3/4"	Pressione aria raccomandata	6,2 bar
Capacità bullone	M27	Pressione sonora	97,8±3 dB(A)
Coppia massima	2.115 Nm	Potenza sonora	108,8±3 dB(A)
Coppia di lavoro	500÷800 Nm	Vibrazioni	5,06 m/s ²
Impulsi al minuto	950	Attacco aria	3/8"
Velocità a vuoto	5.300 giri/min	Diametro interno tubo aria	10 mm
Consumo medio aria	200 l/min	Peso	3,8 kg

928 D1 3/4"

U09280015

Avvitatore ad impulsi in alluminio

CARATTERISTICHE TECNICHE

Attacco quadro	3/4"	Pressione aria raccomandata	6,2 bar
Capacità bullone	M24	Pressione sonora	98,4±3 dB(A)
Coppia massima	1.700 Nm	Potenza sonora	109,4±3 dB(A)
Coppia di lavoro	500÷1.050 Nm	Vibrazioni	9,1 m/s ²
Impulsi al minuto	790	Attacco aria	3/8"
Velocità a vuoto	5.700 giri/min	Diametro interno tubo aria	13 mm
Consumo medio aria	193 l/min	Peso	5,6 kg

~~962,00 €~~

673,00 €

~~877,00 €~~

614,00 €

1"

4.068 Nm

10,3 kg



CORPO IN ALLUMINIO

1"

3.390 Nm

6,8 kg



CORPO IN COMPOSITO

LEGGERO E POTENTE

- 20% di peso rispetto allo standard

910 E1 1"

U09100020

Avvitatore ad impulsi in alluminio

CARATTERISTICHE TECNICHE

Attacco quadro	1"	Pressione aria raccomandata	6,2 bar
Capacità bullone	M33	Pressione sonora	102 ±3 dB(A)
Coppia massima	4.068 Nm	Potenza sonora	113 ±3 dB(A)
Coppia di lavoro	850÷1.300 Nm	Vibrazioni	15,2 m/s ²
Impulsi al minuto	720	Attacco aria	1/2"
Velocità a vuoto	4.500 giri/min	Diametro interno tubo aria	13 mm
Consumo medio aria	243 l/min	Peso	10,3 kg

942 PE1 1"

U09420005

Avvitatore ad impulsi in materiale composito

CARATTERISTICHE TECNICHE

Attacco quadro	1"	Pressione aria raccomandata	6,2 bar
Capacità bullone	M38	Pressione sonora	100,9 ±3 dB(A)
Coppia massima	3.390 Nm	Potenza sonora	111,9 ±3 dB(A)
Coppia di lavoro	203÷1.627 Nm	Vibrazioni	10,6 m/s ²
Impulsi al minuto	900	Attacco aria	1/2"
Velocità a vuoto	5.000 giri/min	Diametro interno tubo aria	19 mm
Consumo medio aria	400 l/min	Peso	6,8 kg

~~1.578,00 €~~

1.049,00 €

~~1.174,00 €~~

822,00 €



235 1/2" M/C16

U02359285



16
PEZZI

Assortimento in cassetta modulare con bussole macchina esagonali

DESCRIZIONE	ART./MISURA	PZ.
Chiavi a bussola macchina con bocca esagonale	235 1/2 M 10-12-13-14-15-16-17-18-19-21-22-24-27-30-32 mm	15
Spina di tenuta	235 MCA/4-6	2
Anello di sicurezza	235 MDA/4-6	2
Prolunghe macchina	236 1/2 M/125	1

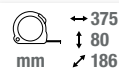

~~239,00 €~~

122,00 €



235 3/4" M/C8

U02359286



8
PEZZI

Assortimento in cassetta modulare con bussole macchina esagonali

DESCRIZIONE	ART./MISURA	PZ.
Chiavi a bussola macchina con bocca esagonale	235 3/4" M 21-22-24-27-30-32-36-41 mm	8

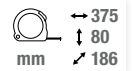

~~245,00 €~~

134,00 €

30.000 Giri/min

0,3 CV
220 W

Ø 6 mm

76 l/min



922 B1

U09220001

Smerigliatrice dritta

CARATTERISTICHE TECNICHE

Consumo medio aria	76 l/min	Vibrazioni	2,42 m/s ²
Pressione aria raccomandata	6,2 bar	Attacco aria	1/4"
Pressione sonora	84,8±3 dB(A)	Diametro interno tubo aria	10 mm
Potenza sonora	99,5±3 dB(A)	Peso	440 g

~~122,00 €~~

72,00 €

23.000 Giri/min

0,3 CV
220 W

Ø 6 mm

76 l/min

90°



922 BP1

U09220004

Smerigliatrice angolare 90°

CARATTERISTICHE TECNICHE

Consumo medio aria	76 l/min	Vibrazioni	4,54 m/s ²
Pressione aria raccomandata	6,2 bar	Attacco aria	1/4"
Pressione sonora	85,9±3 dB(A)	Diametro interno tubo aria	10 mm
Potenza sonora	96,9±3 dB(A)	Peso	555 g

~~173,00 €~~

121,00 €



BUSSOLE MACCHINA RIBASSATE 235 MB



1 1/2"
10 PEZZI

→ 190
↓ 58
mm ↗ 144



1 1/2"
1 1/2"

22 PEZZI

→ 415
↓ 92
mm ↗ 283

235 1/2" MB/C10

U02350530



Assortimento in cassetta modulare con bussole macchina esagonali ribassate

DESCRIZIONE	ART./MISURA	PZ.
Chiavi a bussola macchina ribassate esagonali	235 1/2" M 10-11-12-13-14-15-16-17-18-19	10

95,50 €

61,00 €

236 KE/C22

U02360900



Assortimento in cassetta modulare con bussole macchina esagonali ribassate, prolunga a catena, inserti e accessori

DESCRIZIONE	ART./MISURA	PZ.
Chiavi a bussola macchina ribassate esagonali	235 1/2" MB 13-14-15-16-17-18-19	7
Prolunga a catena	236 KE 1/2"	1
Inserti macchina esagonali	687 E 5-6-8-10-12-14	6
Inserti macchina TORX	687 TX T25-T27-T30-T40-T45-T50-T55	7
Adattatore per bussole	236 KEADP	1

~~395,00 €~~

199,00 €



ADATTATORE PER BUSSOLE SEMPRE INCLUSO



YouTube

236 KE

1 1/2" **1 1/2"** **1 1/4"** **1 1/4"**

Prolunga a catena in alluminio per inserti

CODICE	□	◇	L	H	🛒	
U02360706	1/2"	1/2"	340 mm	24 mm	1,1 kg	124,00 € 60,00 €
U02360711	1/4"	1/4"	260 mm	19 mm	300 g	93,50 € 50,00 €

UTILIZZABILI CON CRICCHETTO O AVVITATORE

236 KE **1 1/2"**

INNESTO DIRETTO PER INSERTI MACCHINA

Da utilizzare con inserti attacco 1/2" (gamme 687 E e 687 TX).



BUSSOLE

Inserire adattatore portabussole articolo 236 KEADP.



236 KE **1 1/4"**

INNESTO DIRETTO PER INSERTI

Da utilizzare con inserti attacco 1/4" (gamme 660 e 664).



BUSSOLE

Inserire adattatore portabussole 660 Q.





EN388



Indice di protezione
3141X

INDICE E POLLICE
CON FUNZIONE
TOUCH



3000 PG CE

Guanti da lavoro Performance Grip

- Certificati EN388 con indice di protezione 3141X.
- Dorso in tessuto traspirante imbottito.
- Palmo in pelle sintetica con speciale texture in silicone per un extra grip.
- Punte delle dita interamente rivestite in pelle sintetica.
- Indice con funzione Touch su indice e pollice.
- Rinforzo con doppio strato di pelle sintetica tra pollice ed indice.
- Pollice rivestito in tessuto assorbente per pulire dal sudore
- Polsino elastico con chiusura a strappo.



TESSUTO
ASSORBENTE
PER SUDORE

CODICE TAGLIA

U30001003	L	21,30 €	14,90 €
U30001004	XL	21,30 €	14,90 €



3787 A

U37870001G

Sedia Racing

- Materiale: pelle in PVC con imbottitura in schiuma stampata.
- Base in nylon con ruote pivotanti in PU diametro 60 mm.
- Pistone a gas Classe 4.
- Altezza schienale dalla seduta: 82 cm.
- Dimensioni seduta: 50x53 cm.
- Altezza seduta da terra: 48-56 cm.
- Altezza totale sedia: 128-136 cm.

200,00 €

149,00 €

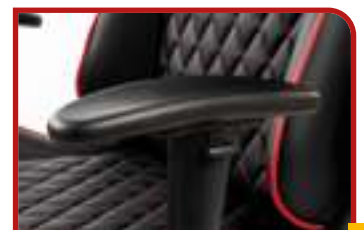

CRICCHETTO REVERSIBILE 237 JS TESTA RIBASSATA: IL TOP DELL'ACCESSIBILITÀ.

SLIM



**MECCANISMO
A 72 DENTI**

Novità



**PULSANTE DI RILASCIO
DELLA BUSSOLA**



**INVERSIONE
A LEVA**

**IMPUGNATURA
ERGONOMICA**

INCLUSO IN TUTTI I KIT

JUST



700 kg



6
CASSETTI

3
MODULI



265
PEZZI

ASSORTIMENTO MANUTENZIONE



515 J6SM
U05150636

RAL 3020 RAL 9005

Carrello JUST con assortimento Manutenzione - 3 cassette

~~1.642,00 €~~ **799,00 €**

DESCRIZIONE	ART	PZ
Pinza regolabile, scalpello, cacciaspine, mazzuola, martello, forbice, cassetta inserti, pinze per anelli elastici, pinza a becchi mezzotondi, pinza universale, tronchese	519 M 150A	122
Giraviti per viti con intaglio, giraviti a croce PHILLIPS®, Giraviti per viti con impronta TORX®, Giraviti per viti con impronta a croce POZIDRIV®	519 M 320	27
Chiavi combinate, bussole, cricchetti e accessori	519 M 601S	116



515

- Piano di lavoro in ABS ad alta resistenza con bordo anticaduta da 15 mm.
- Misura utile del piano di lavoro 560x460 mm.
- Doppia maniglia di trasporto per una maggior manovrabilità.
- Tappetini interni in gomma antiolio.
- Chiusura di sicurezza a serratura centralizzata.
- Ruote in gomma antiolio (Ø 125 mm): due fisse e due pivotanti (una con freno).
- Fornito con ruote già assemblate alla struttura.
- Dimensioni interne cassette:
 - 3 cassette 570x420x60 mm.
 - 2 cassette 570x420x130 mm.
 - 1 cassetto 570x420x270 mm.



Configurazione senza accessori



Novità

ACCIAIO

Pianali in acciaio
2.175 mm - 516 AC/2



265
PEZZI

ASSORTIMENTO MANUTENZIONE



516 SA/STBA
U05160316

RAL
9005

212 kg | mm | 2.175
2.000
650

Arredamento per officina pianale in acciaio

4.602,00 € **2.699,00 €**

Novità



116
PEZZI



1
CASSETTO

3
MODULI

504 SRJM
U05041601

RAL
3020

32 kg | mm | 901
849
452

Carrello multiuso JUST con assortimento
Manutenzione - 1 cassetto

DESCRIZIONE	ART	PZ
Chiavi combinate, bussole, cricchetti e accessori	519 M 601S	116

754,00 € **399,00 €**



002 JSM
U00020021

181
PEZZI

Valigia con assortimento per manutenzione

~~674,00 €~~ **379,00 €**



11 kg | 460 mm | 158 mm | 385 mm

Novità



Novità

100
PEZZI



1/4"

1/2"

8 kg | 415 mm | 92 mm | 283 mm



601 1/4-1/2" JS100
U06010031

Assortimento in cassetta modulare con bussole esagonali ed inserti per avvitatura

~~200,00 €~~ **135,00 €**

Modulare con i cassetti dei carrelli USAG!





Novità

82
PEZZI



1/4" 1/2"

7 kg 415 mm 92 283



601 1/4-1/2" JS82

U06010030

Assortimento in cassetta modulare con bussole esagonali e chiavi combinate

~~215,00 €~~

150,00 €

Modulare con i cassetti dei carrelli USAG!



Novità

41
PEZZI



1/2"

7 kg 415 mm 92 283

601 1/2" JS41

U06010024

Assortimento in cassetta modulare con bussole esagonali ed inserti per avvitatura

~~142,00 €~~

99,00 €

Modulare con i cassetti dei carrelli USAG!





22
PEZZI

1/2"

Novità



Modulare con
i cassettei dei
carrelli USAG!

4 kg | mm | 375
80
186

601 1/2" JS22

U06010023

Assortimento in cassetta modulare
con bussole esagonali

~~113,00 €~~

79,00 €



34
PEZZI

1/4"

Novità



Modulare con i cassettei
dei carrelli USAG!

1 kg | mm | 190
78
165

601 1/4" JS34

U06010021

Assortimento in cassetta modulare
con bussole esagonali ed inserti per avvitatura

~~70,00 €~~

49,00 €



16
PEZZI

1/4"

1/2"

Novità



Modulare con i cassettei
dei carrelli USAG!

1 kg | mm | 190
58
138

601 1/4-1/2" JTXS16

U06010029

Assortimento in cassetta modulare
con bussole TORX®

~~43,00 €~~

30,00 €



CHIAVI DINAMOMETRICHE 810 J

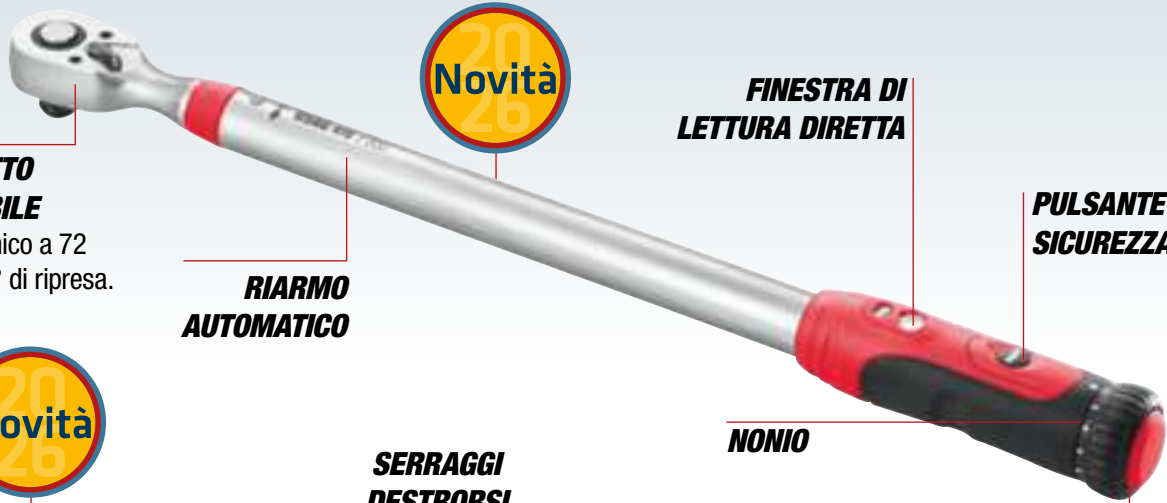

CRICCHETTO REVERSIBILE
con meccanico a 72
denti con 5° di ripresa.

**RIARMO
AUTOMATICO**

**FINESTRA DI
LETTURA DIRETTA**

**PULSANTE DI
SICUREZZA**

NONIO

**MANOPOLA DI
REGOLAZIONE**

**SERRAGGI
DESTORSI**

Novità

**PRECISIONE
±4%**

810 J

ISO 6789

Chiavi dinamometriche a lettura diretta con cricchetto reversibile

- Include dichiarazione di conformità e dichiarazione REACH.

ARTICOLO	CODICE	CAPACITÀ	☑	L (mm)	RISOL.		
810 J 5-25	U08100025	5÷25 Nm	1/4"	323	0,1 Nm	170,00 €	119,00 €
810 J 10-50	U08100050	10÷50 Nm	3/8"	400	0,5 Nm	170,00 €	119,00 €
810 J 20-100	U08100100	20÷100 Nm	1/2"	400	0,5 Nm	170,00 €	119,00 €
810 J 40-200	U08100200	40÷200 Nm	1/2"	517	0,5 Nm	170,00 €	119,00 €
810 J 60-340	U08100340	60÷340 Nm	1/2"	620	1 Nm	220,00 €	154,00 €
810 J 150-750	U08100750	150÷750 Nm	3/4"	1200	2,5 Nm	785,00 €	499,00 €

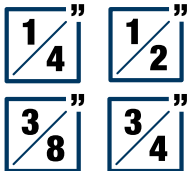

YouTube



692 J32
U06920042

32
PEZZI



Assortimento di inserti
con cricchetto

~~55,00 €~~

38,50 €

692 J49
U06920041

49
PEZZI



Assortimento di inserti con
prolunga portainseriti

~~42,60 €~~

29,80 €

692 J100
U06920043

100
PEZZI



Assortimento di inserti
con impronte speciali

~~65,50 €~~

45,80 €

CHIAVE COMBINATA 285 J



7
PEZZI

8÷19 mm



285 J/DS7

U02851745

- Serie di 7 chiavi combinate**
- 285 J/8-10-12-13-14-17-19 mm.
 - Fornita con supporto in plastica.

~~58,50 €~~ **40,00 €**

12
PEZZI

8÷19 mm



285 J/DS12

U02851746

- Serie di 12 chiavi combinate**
- 285 J/8-9-10-11-12-13-14-15-16-17-19 mm.
 - Fornita con supporto in plastica.

~~97,50 €~~ **61,00 €**



16
PEZZI

6÷24 mm

285 J/B16

U02851740

- Serie di 16 chiavi combinate**
- 285 J/6-7-8-9-10-11-12-13-14-15-16-17-18-19-22-24 mm.
 - Borsa avvolgibile in dotazione.

~~128,00 €~~ **79,00 €**

CHIAVE A CRICCHETTO PIATTA 285 KB



7
PEZZI

8÷19 mm



285 KB/DS7

U02856341

- Serie di 7 chiavi combinate a cricchetto piatte**
- 285 KB/8-10-12-13-14-17-19 mm.
 - Fornita con supporto in plastica.

~~111,00 €~~ **77,50 €**

12
PEZZI

8÷19 mm



285 KB/DS12

U02856342

- Serie di 12 chiavi combinate a cricchetto piatte**
- 285 KB/8-9-10-11-12-13-14-15-16-17-19 mm.
 - Fornita con supporto in plastica.

~~190,00 €~~ **130,00 €**

Sei un utilizzatore finale e vuoi contattarci?

Vai sul nostro sito:



usag.it/it/contacts/support



Oppure chiamaci: tel. 02.8295.3731 da Lunedì a Venerdì dalle 08:30 alle 19:30.

Offerta valida fino al 28 febbraio 2027 salvo esaurimento scorte, presso i Rivenditori che aderiscono all'iniziativa.

Tutti i prezzi sono da intendersi in Euro, IVA esclusa. Le immagini riprodotte in questa brochure sono indicative. Stanley Black & Decker Italia S.r.l. si riserva in ogni momento di modificare le caratteristiche tecniche dei prodotti.



Stanley Black & Decker Italia S.r.l.

Sede operativa:

Via Volta, 3 - 21020 - Monvalle (VA)

Tel. +39 0332 790 111 - info.mv@usag.it

usag.it

