

**iMilani**

innovative  
italian  
ideas

**iMiNOW**  
MERITI IL MEGLIO... ADESSO



CASSETTE E CONTENITORI IN PLASTICA PER INDUSTRIA E LOGISTICA



**IN VIGORE**

DAL 01/04/2022

# PERSONALIZZAZIONI

2



A PARTIRE DA  
**138 €\***  
 \* MINIMO 50/100 PEZZI

**I NOSTRI COLORI  
 DISPONIBILI SU RICHIESTA**

2X	05	03	HE	24
2N	1G	1C	JV	3Z
04	XB	3P	27	1G
QD	JW	43	2F	02
1B	XL	08	01	07

DISPONIBILI SU RICHIESTA PER I SEGUENTI MODELLI  
**ATHENA - COMPAT - DELTA - MINERVA - RK - ZEUS**

**25 COLORI DISPONIBILI**



A PARTIRE DA  
**0,72 €\***  
 \* MINIMO 100 PEZZI

**MARCHIATURA PERSONALIZZATA  
 DISPONIBILE SU RICHIESTA**

- a caldo nei colori disponibili  
**PER UN MINIMO DI 100 PEZZI**
- in rilievo con inserto in acciaio nello stampo  
**PER UN MINIMO DI 500 PEZZI**

**6 COLORI DI NASTRO DISPONIBILI**

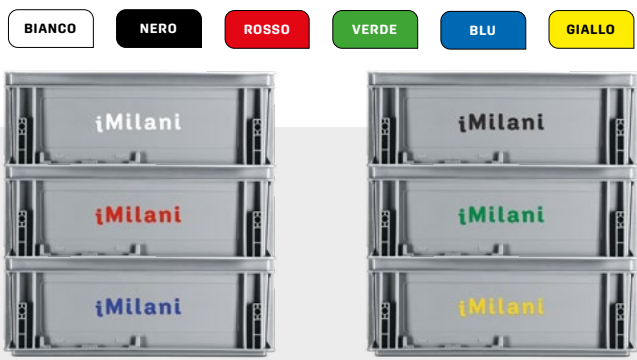

# PRACTIBOX

## C-PARTS



Le cassettiere serie **PRACTIBOX** sono composte da una struttura in ABS di colore grigio e da cassette in polistirolo trasparente ad alta resistenza meccanica. Disponibili in modelli diversi, per profondità ed altezza, hanno in comune la larghezza di 600 mm che permette di sovrapporli consentendo le più svariate combinazioni. L'abbinamento con i pannelli posteriori in acciaio consente di organizzare e razionalizzare lo spazio.

3



Pannello posteriore  
per installazione a parete

PR F100 0001  
600x41x1000 h mm  
Prezzo unitario € 33,72

PR F150 0001  
600x41x1500 h mm  
Prezzo unitario € 34,66

PR F195 0001  
600x41x1950 h mm  
Prezzo unitario € 39,44



Abbinabile al pannello posteriore  
per posizionamento libero

Dimensioni  
600 x 300 x 100 h mm

PR DBAS 0001  
Base opzionale per scaffale  
Prezzo unitario € 44,95



Cassettiere con 9 cassette  
Dimensioni  
600 x 69 x 77 h mm

PR 9077 0001  
Confezione pz. 2  
Prezzo unitario € 14,29



Cassettiere con 6 cassette  
Dimensioni  
600 x 98 x 112 h mm

PR 6112 0001  
Confezione pz. 2  
Prezzo unitario € 17,45



Cassettiere con 5 cassette  
Dimensioni  
600 x 141 x 164 h mm

PR 5164 0001  
Confezione pz. 1  
Prezzo unitario € 27,77



Cassettiere con 4 cassette  
Dimensioni  
600 x 174 x 206 h mm

PR 4206 0001  
Confezione pz. 1  
Prezzo unitario € 36,49



Cassettiere con 3 cassette  
Dimensioni  
600 x 209 x 240 h mm

PR 3240 0001  
Confezione pz. 1  
Prezzo unitario € 42,85



Cassettiere con 2 cassette  
Dimensioni  
600 x 311 x 353 h mm

PR 2353 0001  
Confezione pz. 1  
Prezzo unitario € 80,13



Dimensioni  
600 x 28 x 500 h mm

PR F050 0001  
Pannello posteriore  
Prezzo unitario € 20,86



Dimensioni  
600 x 150 x 500 h mm

PR D050 0001  
Telaio da banco senza  
cassette  
Prezzo unitario € 37,97



innovative  
italian  
ideas  
**imilani**

Tutto in ordine e ben in vista per un magazzino flessibile e funzionale: questo è il risultato ottenuto dallo studio e dalla realizzazione delle cassette in polipropilene serie **RK** e degli appositi scaffali per il loro contenimento. Disponibili in undici diverse misure per rispondere ad ogni esigenza.

4

**DISPONIBILI ANCHE IN:**  
**PROFONDITÀ 300 / 600 mm**  
**ESD (CONDUTTIVO)**

### PROFONDITÀ 400 mm

### PROFONDITÀ 500 mm



Dimensioni  
**120 x 400 x 100 h mm**

Dimensioni  
**160 x 400 x 100 h mm**

Dimensioni  
**240 x 400 x 100 h mm**

Dimensioni  
**120 x 500 x 100 h mm**

Dimensioni  
**160 x 500 x 100 h mm**

Dimensioni  
**240 x 500 x 100 h mm**

COLORE	RK 4012 5104		RK 4016 5104		RK 4024 5104		RK 5012 5104		RK 5016 5104		RK 5024 5104	
	Confezione pz. ☐	32	Confezione pz. ☐	24	Confezione pz. ☐	16	Confezione pz. ☐	32	Confezione pz. ☐	24	Confezione pz. ☐	16
	Prezzo unitario	€ 4,88	Prezzo unitario	€ 5,35	Prezzo unitario	€ 6,74	Prezzo unitario	€ 5,51	Prezzo unitario	€ 5,72	Prezzo unitario	€ 7,52

## ACCESSORI



Divisorio trasversale per cassette 4012/5012



Divisorio trasversale per cassette 4016/5016



Divisorio trasversale per cassette 4024/5024



Divisorio longitudinale zincato per cassette 4016/4024



Divisorio longitudinale zincato per cassette 5016/5024

RK D120 6896  
 Confezione pz. ☐ 1  
 Prezzo unitario € 0,72

RK D160 6896  
 Confezione pz. ☐ 1  
 Prezzo unitario € 0,80

RK D240 6896  
 Confezione pz. ☐ 1  
 Prezzo unitario € 1,28

RK D400 0099  
 Confezione pz. ☐ 1  
 Prezzo unitario € 3,55

RK D500 0099  
 Confezione pz. ☐ 1  
 Prezzo unitario € 4,08

### PROFONDITÀ 400 mm

### PROFONDITÀ 500 mm



Dimensioni  
**120 x 400 x 100 h mm**

Dimensioni  
**160 x 400 x 100 h mm**

Dimensioni  
**240 x 400 x 100 h mm**

Dimensioni  
**120 x 500 x 100 h mm**

Dimensioni  
**160 x 500 x 100 h mm**

Dimensioni  
**240 x 500 x 100 h mm**

COLORE	RK 4012 5401		RK 4016 5401		RK 4024 5401		RK 5012 5401		RK 5016 5401		RK 5024 5401	
	Confezione pz. ☐	32	Confezione pz. ☐	24	Confezione pz. ☐	16	Confezione pz. ☐	32	Confezione pz. ☐	24	Confezione pz. ☐	16
	Prezzo unitario	€ 3,91	Prezzo unitario	€ 4,27	Prezzo unitario	€ 5,39	Prezzo unitario	€ 4,40	Prezzo unitario	€ 4,57	Prezzo unitario	€ 6,02

# RK-BOX

## C-PARTS



Scaffale per la collocazione delle cassette serie **RK**. Realizzati in acciaio di colore grigio RAL 7000 - possono essere sovrapposti ed essere rialzati ed isolati dal pavimento grazie ad un apposito zoccolo in lamiera d'acciaio verniciata.

**DISPONIBILI ANCHE IN:  
PROFONDITÀ 300 e 600 mm**

5

### PROFONDITÀ 400 mm



Dimensioni  
**500 x 400 x 545 h mm**

COLORE	RK BX41 5104
	16 cassette RK 4012
	Confezione pz. 1
	Prezzo unitario € 222,67



Dimensioni  
**500 x 400 x 545 h mm**

COLORE	RK BX42 5104
	12 cassette RK 4016
	Confezione pz. 1
	Prezzo unitario € 194,04



Dimensioni  
**500 x 400 x 545 h mm**

COLORE	RK BX44 5104
	8 cassette RK 4024
	Confezione pz. 1
	Prezzo unitario € 169,13

### PROFONDITÀ 500 mm



Dimensioni  
**500 x 500 x 545 h mm**

COLORE	RK BX51 5104
	16 cassette RK 5012
	Confezione pz. 1
	Prezzo unitario € 249,20



Dimensioni  
**500 x 500 x 545 h mm**

COLORE	RK BX52 5104
	12 cassette RK 5016
	Confezione pz. 1
	Prezzo unitario € 214,03



Dimensioni  
**500 x 500 x 545 h mm**

COLORE	RK BX54 5104
	8 cassette RK 5024
	Confezione pz. 1
	Prezzo unitario € 189,90

## ACCESSORI



Zoccolo profondità 400 mm

RK F400 0001

Confezione pz. 1

Prezzo unitario € 26,82



Zoccolo profondità 500 mm

RK F500 0001

Confezione pz. 1

Prezzo unitario € 52,00



Sovrapponibili con scaffali della stessa profondità e di profondità decrescente per sfruttare al massimo lo spazio disponibile.



Completati di guide e fermi per cassette.



Consulta il nostro catalogo per altre configurazioni e misure disponibili.

**imilani**  
Innovative Italian Ideas

# COMPAT

## C-PARTS



I contenitori serie **COMPAT** sono la soluzione ideale ad ogni problema di stoccaggio: in magazzino, in officina, lungo le linee di montaggio. Consentono di avere sempre a portata di mano e ben in vista il contenuto, rendendolo prelevabile con estrema facilità.

6

MISURA  
**1**



Dimensioni  
**169/136 x 103 x 75 h mm**

COLORE	CO	C001	5101
	CO	C001	5102
	CO	C001	5103
	CO	C001	5104
	CO	C001	5105
Confezione pz.			☞ 50
Prezzo unitario			€ 1,09

MISURA  
**2**



Dimensioni  
**230/202x150x125hmm**

COLORE	CO	C002	5101
	CO	C002	5102
	CO	C002	5103
	CO	C002	5104
	CO	C002	5105
Confezione pz.			☞ 54
Prezzo unitario			€ 2,11

MISURA  
**3A2**



Dimensioni  
**350/296x210x145hmm**

COLORE	CO	C3A2	5101
	CO	C3A2	5102
	CO	C3A2	5103
	CO	C3A2	5104
	CO	C3A2	5105
Confezione pz.			☞ 21
Prezzo unitario			€ 5,05

MISURA  
**3**



Dimensioni  
**350/291x210x200hmm**

COLORE	CO	C003	5101
	CO	C003	5102
	CO	C003	5103
	CO	C003	5104
	CO	C003	5105
Confezione pz.			☞ 15
Prezzo unitario			€ 5,96

### ACCESSORI



CO C1S2 5407

Divisorio 2 scomparti per misura 1

Confezione pz. ☞ 25

Prezzo unitario € 1,32



CO C2S2 5407

Divisorio 2 scomparti per misura 2

Confezione pz. ☞ 25

Prezzo unitario € 1,79

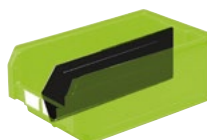

CD C3A2 7107

Divisorio longit. in plastica per misura 3A2

Confezione pz. ☞ 10

Prezzo unitario € 2,04



CD C003 7107

Divisorio longit. in plastica per misura 3

Confezione pz. ☞ 10

Prezzo unitario € 2,67



CO C1S4 5407

Divisorio 4 scomparti per misura 1

Confezione pz. ☞ 25

Prezzo unitario € 1,32



CO C2S4 5407

Divisorio 4 scomparti per misura 2

Confezione pz. ☞ 25

Prezzo unitario € 1,79



I contenitori Compat possono essere suddivisi longitudinalmente e trasversalmente per le unità di carico con più prodotti al loro interno.

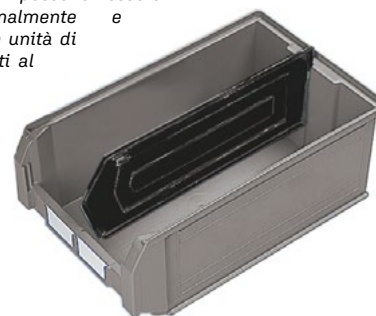

# COMPAT

## C-PARTS



I contenitori a bocca di lupo **COMPAT** sono impilabili in modo stabile e sicuro e la pronta disponibilità del materiale non viene meno anche quando sono sovrapposti. Un rinforzo laterale sul fondo permette di accatastare i contenitori con la massima sicurezza anche a pieno carico.

### MISURA 4A2



Dimensioni  
500/450 x 310 x 145 h mm

### MISURA 4



Dimensioni  
500/443 x 310 x 200 h mm

### MISURA 4A5



Dimensioni  
500/445 x 310 x 300 h mm

### MISURA 5P4



Dimensioni  
535/452 x 472 x 300 h mm

### MISURA 5



Dimensioni  
720/636 x 472 x 300 h mm

COLORE	CO	C	5101	5102	5103	5104	5105	Confezione pz.	Prezzo unitario
COLORE	CO	C4A2	5101	5102	5103	5104	5105	14	€ 10,28
	CO	C4A2	5102	5103	5104	5105			
	CO	C4A2	5103	5104	5105				
	CO	C4A2	5104	5105					
	CO	C4A2	5105						
COLORE	CO	C004	5101	5102	5103	5104	5105	10	€ 11,65
	CO	C004	5102	5103	5104	5105			
	CO	C004	5103	5104	5105				
	CO	C004	5104	5105					
	CO	C004	5105						
COLORE	CO	C4A5	5101	5102	5103	5104	5105	6	€ 14,19
	CO	C4A5	5102	5103	5104	5105			
	CO	C4A5	5103	5104	5105				
	CO	C4A5	5104	5105					
	CO	C4A5	5105						
COLORE	CO	Z5P4	5101	5102	5103	5104	5105	18	€ 26,63
	CO	Z5P4	5102	5103	5104	5105			
	CO	Z5P4	5103	5104	5105				
	CO	Z5P4	5104	5105					
	CO	Z5P4	5105						
COLORE	CO	Z005	5101	5102	5103	5104	5105	12	€ 33,67
	CO	Z005	5102	5103	5104	5105			
	CO	Z005	5103	5104	5105				
	CO	Z005	5104	5105					
	CO	Z005	5105						

## ACCESSORI



CD C4A2 0099

Divisorio longit. zincato per misura 4A2

Confezione pz. 1

Prezzo unitario € 7,03

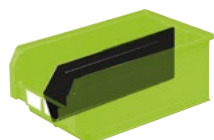

CD C004 7107

Divisorio longit. in plastica per misura 4

Confezione pz. 10

Prezzo unitario € 3,68

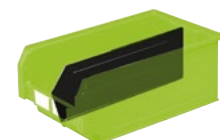

CD C4A5 7107

Divisorio longit. in plastica per misura 4A5

Confezione pz. 10

Prezzo unitario € 5,13



CS Z5P4 0199

Divisorio longit. zincato con coppia supporti trasvers. mis. 5P4

Confezione pz. 1

Prezzo unitario € 11,04



CS Z005 0199

Divisorio longit. zincato con coppia supporti trasvers. mis. 5

Confezione pz. 1

Prezzo unitario € 12,02



# COMPAT

## C-PARTS



ECOGREEN

8



MISURA  
**1**



Dimensioni  
**169/136 x 103 x 75 h mm**

MISURA  
**2**



Dimensioni  
**230/202 x 150 x 125 h mm**

MISURA  
**3A2**



Dimensioni  
**350/296 x 210 x 145 h mm**

MISURA  
**3**



Dimensioni  
**350/291 x 210 x 200 h mm**

MISURA  
**4**



Dimensioni  
**500/443 x 310 x 200 h mm**

CO C001 5401

Confezione pz. 50

Prezzo unitario **€ 0,85**

CO C002 5401

Confezione pz. 54

Prezzo unitario **€ 1,75**

CO C3A2 5401

Confezione pz. 21

Prezzo unitario **€ 4,33**

CO C003 5401

Confezione pz. 15

Prezzo unitario **€ 5,06**

CO C004 5401

Confezione pz. 10

Prezzo unitario **€ 9,94**

### ACCESSORI



ECOGREEN

CO C1S2 5407

Divisorio 2 scomparti per misura 1

Confezione pz. 25

Prezzo unitario **€ 1,32**



ECOGREEN

CO C2S2 5407

Divisorio 2 scomparti per misura 2

Confezione pz. 25

Prezzo unitario **€ 1,79**

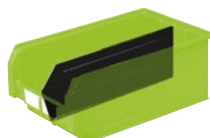

CD C3A2 7107

Divisorio longit. in plastica per misura 3A2

Confezione pz. 10

Prezzo unitario **€ 2,04**

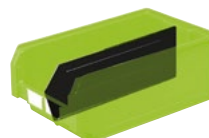

CD C003 7107

Divisorio longit. in plastica per misura 3

Confezione pz. 10

Prezzo unitario **€ 2,67**



CD C004 7107

Divisorio longit. in plastica per misura 4

Confezione pz. 10

Prezzo unitario **€ 3,68**



ECOGREEN

CO C1S4 5407

Divisorio 4 scomparti per misura 1

Confezione pz. 25

Prezzo unitario **€ 1,32**



ECOGREEN

CO C2S4 5407

Divisorio 4 scomparti per misura 2

Confezione pz. 25

Prezzo unitario **€ 1,79**



L' Ecogreen rappresenta una soluzione ecologica poiché dona nuova vita alla plastica riciclata derivante dalla valorizzazione dei rifiuti plastici da post consumo.



# ZEUS

## C-PARTS



Le cassette serie **ZEUS** rispondono alle più specifiche esigenze di contenimento, movimentazione e stoccaggio delle merci. Maneggevoli, leggere e facili da pulire grazie all'interno perfettamente liscio, sono dotate di un robusto bordo che consente la sovrapposizione in modo stabile e sicuro.



### MISURA 701



Dimensioni  
**144 x 91 x 70 h mm**

COLORE	ZE	Z701	5101
	ZE	Z701	5102
	ZE	Z701	5103
	ZE	Z701	5104
	ZE	Z701	5105
Confezione pz.			📦 50
Prezzo unitario			€ 1,43

### MISURA 702



Dimensioni  
**144 x 139 x 70 h mm**

COLORE	ZE	Z702	5101
	ZE	Z702	5102
	ZE	Z702	5103
	ZE	Z702	5104
	ZE	Z702	5105
Confezione pz.			📦 30
Prezzo unitario			€ 1,74

### MISURA 272-2



Dimensioni  
**211 x 148 x 126 h mm**

COLORE	ZE	Z002	5101
	ZE	Z002	5102
	ZE	Z002	5103
	ZE	Z002	5104
	ZE	Z002	5105
Confezione pz.			📦 54
Prezzo unitario			€ 2,92



### MISURA 272-3A2



Dimensioni  
**310 x 210 x 145 h mm**

COLORE	ZE	Z3A2	5101
	ZE	Z3A2	5102
	ZE	Z3A2	5103
	ZE	Z3A2	5104
	ZE	Z3A2	5105
Confezione pz.			📦 21
Prezzo unitario			€ 5,15

### MISURA 272-4A2



Dimensioni  
**465 x 315 x 120 h mm**

COLORE	ZE	Z4A2	5101
	ZE	Z4A2	5102
	ZE	Z4A2	5103
	ZE	Z4A2	5104
	ZE	Z4A2	5105
Confezione pz.			📦 16
Prezzo unitario			€ 8,90

### MISURA 272-4



Dimensioni  
**465 x 315 x 200 h mm**

COLORE	ZE	Z004	5101
	ZE	Z004	5102
	ZE	Z004	5103
	ZE	Z004	5104
	ZE	Z004	5105
Confezione pz.			📦 10
Prezzo unitario			€ 10,96

### MISURA 272-4A5



Dimensioni  
**465 x 315 x 300 h mm**

COLORE	ZE	Z4A5	5101
	ZE	Z4A5	5102
	ZE	Z4A5	5103
	ZE	Z4A5	5104
	ZE	Z4A5	5105
Confezione pz.			📦 6
Prezzo unitario			€ 14,84

# SQUARE

STEEL

RAL  
7000

Gli scaffali **SQUARE** sono sovrapponibili e possono creare vere e proprie pareti attrezzate, in base agli spazi disponibili. Gli scaffali **SQUARE** sono realizzati con struttura in acciaio colore grigio RAL7000, in 8 diverse configurazioni, sia per cassette serie Zeus che per contenitori serie Compat.

10

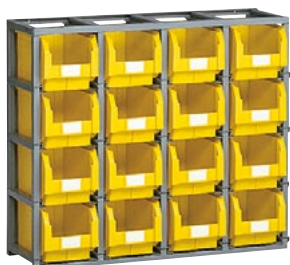

Contenitori esclusi



Contenitori esclusi

Dimensioni  
**1025 x 310 x 885 h mm**

SQ	160	03
Q.tà max cassette	16	
Adatta per contenitori COMPAT	mis. 3	
Prezzo unitario	<b>€ 257,40</b>	



Telai sovrapposti

2	max 3
Portata max 1+1 telai	Portata max 1+2 telai
960 kg	640 kg
Portata di ogni box	
60 kg	40 kg

Dimensioni  
**1765 x 310 x 885 h mm**

SQ	280	03
Q.tà max cassette	28	
Adatta per contenitori COMPAT	mis. 3	
Prezzo unitario	<b>€ 382,59</b>	



Telai sovrapposti

2	max 3
Portata max 1+1 telai	Portata max 1+2 telai
1680 kg	1120 kg
Portata di ogni box	
60 kg	40 kg

ACCESSORI



Zoccolo

SQ	B10	23
<b>1020 x 315 x 85 h mm</b>		
Prezzo unitario	<b>€ 62,33</b>	



Coperchio para polvere

SQ	C10	23
<b>1020 x 315 x 20 h mm</b>		
Prezzo unitario	<b>€ 29,94</b>	



Zoccolo

SQ	B17	63
<b>1765 x 315 x 85 h mm</b>		
Prezzo unitario	<b>€ 85,41</b>	



Coperchio para polvere

SQ	C17	63
<b>1765 x 315 x 20 h mm</b>		
Prezzo unitario	<b>€ 39,03</b>	



Contenitori esclusi

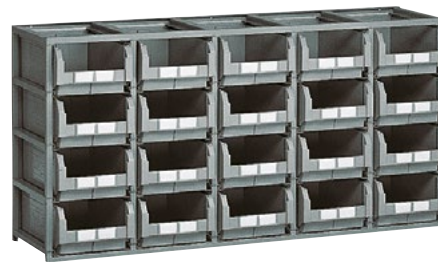

Contenitori esclusi

Dimensioni  
**1075 x 460 x 885 h mm**

SQ	120	04
Q.tà max cassette	12	
Adatta per contenitori COMPAT	mis. 4	
ZEUS	mis. 272-4	
Prezzo unitario	<b>€ 245,64</b>	

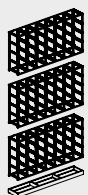

Telai sovrapposti

max 3	
Portata di ogni telaio	
1200 kg	
Portata di ogni box	
100 kg	

Dimensioni  
**1765 x 460 x 885 h mm**

SQ	200	04
Q.tà max cassette	20	
Adatta per contenitori COMPAT	mis. 4	
ZEUS	mis. 272-4	
Prezzo unitario	<b>€ 347,48</b>	



Telai sovrapposti

max 3	
Portata di ogni telaio	
1600 kg	
Portata di ogni box	
80 kg	

ACCESSORI



Zoccolo

SQ	B10	74
<b>1070 x 465 x 85 h mm</b>		
Prezzo unitario	<b>€ 72,67</b>	



Coperchio para polvere

SQ	C10	74
<b>1070 x 465 x 20 h mm</b>		
Prezzo unitario	<b>€ 35,62</b>	



Zoccolo

SQ	B17	64
<b>1075 x 465 x 85 h mm</b>		
Prezzo unitario	<b>€ 80,12</b>	



Coperchio para polvere

SQ	C17	64
<b>1765 x 465 x 20 h mm</b>		
Prezzo unitario	<b>€ 39,17</b>	

# WHAT



# IT?

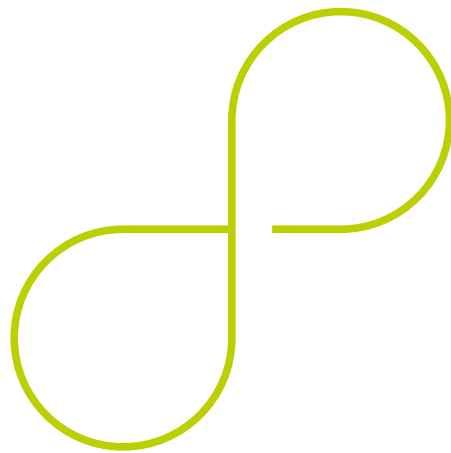

UN  
NOME

—  
INFINITE  
POSSIBILITÀ

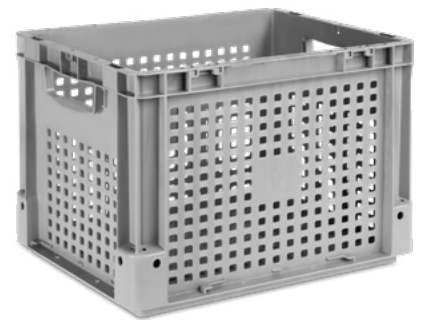

# NEXIT

NOVITÀ 2022

Salvo per le altezze 75 e 120 mm, disponibili solo con maniglia chiusa, tutte le cassette sono fornite sempre con maniglia aperta. All'interno di ogni confezione è presente una coppia di carter di chiusura, applicabili con estrema facilità in qualsiasi momento, rendendo **TEKNO** estremamente flessibile per future esigenze operative.

12

### DISPONIBILE CON



Fondo liscio

**PORTATA 20 KG**

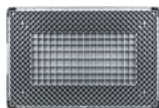

Fondo rinforzato

**PORTATA 35/50 KG**



**CARTER DI CHIUSURA MANIGLIE INCLUSO**

SERIE

## 400x300



Dimensioni  
**400 x 300 x 75 h mm**



Dimensioni  
**400 x 300 x 120 h mm**



Dimensioni  
**400 x 300 x 170 h mm**



Dimensioni  
**400 x 300 x 220 h mm**

COLORE	TK	4308A	5101
	TK	4308A	5104
Confezione pz.  14			
<b>Fondo liscio</b>			
Prezzo unitario <b>€ 6,67</b>			
COLORE	TK	4308C	5101
	TK	4308C	5104
Confezione pz.  14			
<b>Fondo rinforzato</b>			
Prezzo unitario <b>€ 9,69</b>			

COLORE	TK	4312A	5101
	TK	4312A	5104
Confezione pz.  8			
<b>Fondo liscio</b>			
Prezzo unitario <b>€ 7,45</b>			
COLORE	TK	4312C	5101
	TK	4312C	5104
Confezione pz.  8			
<b>Fondo rinforzato</b>			
Prezzo unitario <b>€ 9,81</b>			

COLORE	TK	4317B	5101
	TK	4317B	5104
Confezione pz.  6			
<b>Fondo liscio</b>			
Prezzo unitario <b>€ 8,79</b>			
COLORE	TK	4317D	5101
	TK	4317D	5104
Confezione pz.  6			
<b>Fondo rinforzato</b>			
Prezzo unitario <b>€ 11,05</b>			

COLORE	TK	4322B	5101
	TK	4322B	5104
Confezione pz.  4			
<b>Fondo liscio</b>			
Prezzo unitario <b>€ 9,80</b>			
COLORE	TK	4322D	5101
	TK	4322D	5104
Confezione pz.  4			
<b>Fondo rinforzato</b>			
Prezzo unitario <b>€ 11,88</b>			

### ACCESSORI



Coperchio separato

COLORE	NX	43SE	5101
	NX	43SE	5104
Confezione pz.  1			
Prezzo unitario <b>€ 4,07</b>			

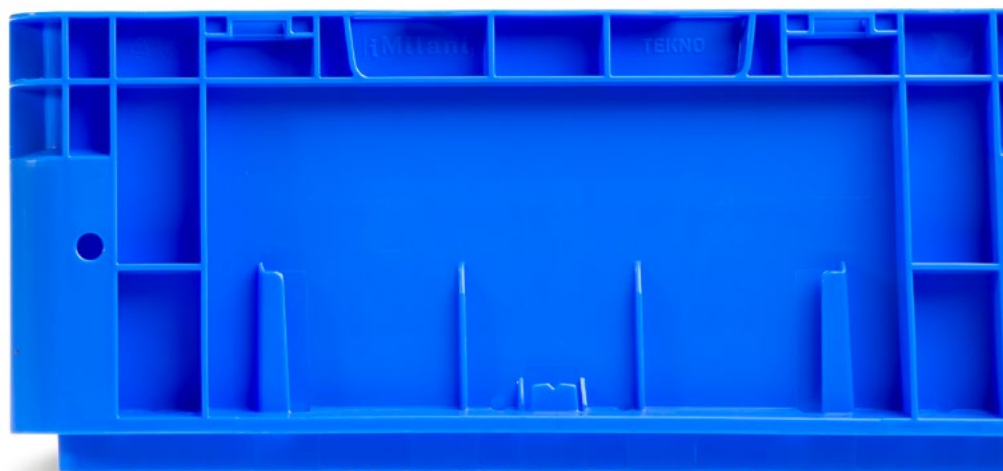



Sono previsti 2 portadocumenti su due lati adiacenti, lungo e corto.

## SERIE 600x400

### ACCESSORI



Coperchio separato

COLORE	NX	64SE	5101
	NX	64SE	5104
Confezione pz.  1			

Prezzo unitario € 8,06

Coperchio incernierato

COLORE	NX	64HG	5101
	NX	64HG	5104
Confezione pz.  1			

Prezzo unitario € 8,06



Dimensioni  
600 x 400 x 75 h mm

COLORE	TK	6408A	5101
	TK	6408A	5104
Confezione pz.  7			

Fondo liscio

Prezzo unitario € 9,18



COLORE	TK	6408C	5101
	TK	6408C	5104
Confezione pz.  7			

Fondo rinforzato

Prezzo unitario € 12,75



Dimensioni  
600 x 400 x 120 h mm

COLORE	TK	6412A	5101
	TK	6412A	5104
Confezione pz.  4			

Fondo liscio

Prezzo unitario € 10,57



COLORE	TK	6412C	5101
	TK	6412C	5104
Confezione pz.  4			

Fondo rinforzato

Prezzo unitario € 13,83



Dimensioni  
600 x 400 x 170 h mm

COLORE	TK	6417B	5101
	TK	6417B	5104
Confezione pz.  6			

Fondo liscio

Prezzo unitario € 12,03



COLORE	TK	6417D	5101
	TK	6417D	5104
Confezione pz.  6			

Fondo rinforzato

Prezzo unitario € 15,94



Dimensioni  
600 x 400 x 220 h mm

COLORE	TK	6422B	5101
	TK	6422B	5104
Confezione pz.  2			

Fondo liscio

Prezzo unitario € 15,75



COLORE	TK	6422D	5101
	TK	6422D	5104
Confezione pz.  2			

Fondo rinforzato

Prezzo unitario € 18,88



Dimensioni  
600 x 400 x 280 h mm

COLORE	TK	6428B	5101
	TK	6428B	5104
Confezione pz.  2			

Fondo liscio

Prezzo unitario € 19,24



COLORE	TK	6428D	5101
	TK	6428D	5104
Confezione pz.  2			

Fondo rinforzato

Prezzo unitario € 24,04



Dimensioni  
600 x 400 x 320 h mm

COLORE	TK	6432B	5101
	TK	6432B	5104
Confezione pz.  3			

Fondo liscio

Prezzo unitario € 21,66



COLORE	TK	6432D	5101
	TK	6432D	5104
Confezione pz.  3			

Fondo rinforzato

Prezzo unitario € 24,99



Dimensioni  
600 x 400 x 420 h mm

COLORE	TK	6442B	5101
	TK	6442B	5104
Confezione pz.  1			

Fondo liscio

Prezzo unitario € 28,97



COLORE	TK	6442D	5101
	TK	6442D	5104
Confezione pz.  1			

Fondo rinforzato

Prezzo unitario € 30,96



Le cassette serie **ATHENA**, per varietà di materiali impiegati e dimensioni, trovano utilizzo in tutti i settori e rispondono in modo ottimale sia alle esigenze di stoccaggio che di distribuzione. Impilabili con e senza coperchio, sono conformi alle dimensioni degli euro-pallet.

14



Fondo chiuso  
**PORTATA 15 KG**



Fondo chiuso  
**PORTATA 15 KG**

### SERIE 300x200

### SERIE 400x300



Dimensioni  
**300 x 200 x 120 h mm**

Dimensioni  
**300 x 200 x 170 h mm**

Dimensioni  
**400 x 300 x 120 h mm**

Dimensioni  
**400 x 300 x 170 h mm**

Dimensioni  
**400 x 300 x 220 h mm**

Dimensioni  
**400 x 300 x 325 h mm**

COLORE	AT 3212A 5101		AT 3217A 5101		AT 4312A 5101		AT 4317A 5101		AT 4322A 5101		AT 4332A 5101	
	AT	51XB	AT	51XB	AT	51XB	AT	51XB	AT	51XB	AT	51XB
	Confezione pz. ☞ 16		Confezione pz. ☞ 12		Confezione pz. ☞ 8		Confezione pz. ☞ 6		Confezione pz. ☞ 4		Confezione pz. ☞ 2	
	Prezzo unitario € 5,39		Prezzo unitario € 5,88		Prezzo unitario € 7,45		Prezzo unitario € 9,44		Prezzo unitario € 10,23		Prezzo unitario € 14,93	

## ACCESSORI



Coppia ganci di chiusura integrabili con sigillo di sicurezza



Molla blocco documenti in acciaio

AT LOCK 8113

Confezione pz. ☞ 10

Prezzo unitario € 0,38

SPRING 0099

Confezione pz. ☞ 10

Prezzo unitario € 0,33

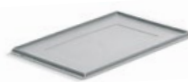

Coperchio incernierato

COLORE	AT 32HG 5101		AT 32HG 51XB	
	AT	51XB	AT	51XB

**300 x 200 mm**

Confezione pz. ☞ 10

Prezzo unitario € 3,05



Coperchio incernierato

COLORE	AT 43HG 5101		AT 43HG 51XB	
	AT	51XB	AT	51XB

**400 x 300 mm**

Confezione pz. ☞ 10

Prezzo unitario € 4,07



Coperchio incernierato

COLORE	AT 64HG 5101		AT 64HG 51XB	
	AT	51XB	AT	51XB

**600 x 400 mm**

Confezione pz. ☞ 10

Prezzo unitario € 8,06



Fondo chiuso  
**PORTATA 20 KG**

### SERIE 600x400



Dimensioni  
**600 x 400 x 120 h mm**

Dimensioni  
**600 x 400 x 170 h mm**

Dimensioni  
**600 x 400 x 220 h mm**

Dimensioni  
**600 x 400 x 280 h mm**

Dimensioni  
**600 x 400 x 320 h mm**

Dimensioni  
**600 x 400 x 430 h mm**

COLORE	AT 6412A 5101		AT 6417A 5101		AT 6422A 5101		AT 6428A 5101		AT 6432A 5101		AT 6443B 5101	
	AT	51XB	AT	51XB	AT	51XB	AT	51XB	AT	51XB	AT	51XB
	Confezione pz. ☞ 4		Confezione pz. ☞ 3		Confezione pz. ☞ 2		Confezione pz. ☞ 2		Confezione pz. ☞ 3		Confezione pz. ☞ 1	
	Prezzo unitario € 12,32		Prezzo unitario € 15,14		Prezzo unitario € 19,65		Prezzo unitario € 22,91		Prezzo unitario € 25,57		Prezzo unitario € 32,83	



### SERIE 400x300



Dimensioni  
**400 x 300 x 120 h mm**

AT 4312A 5401  
Confezione pz. 8  
Prezzo unitario **€ 6,07**



Dimensioni  
**400 x 300 x 170 h mm**

AT 4317A 5401  
Confezione pz. 6  
Prezzo unitario **€ 7,84**



Dimensioni  
**400 x 300 x 220 h mm**

AT 4322A 5401  
Confezione pz. 4  
Prezzo unitario **€ 8,77**



Dimensioni  
**400 x 300 x 325 h mm**

AT 4332A 5401  
Confezione pz. 2  
Prezzo unitario **€ 11,96**

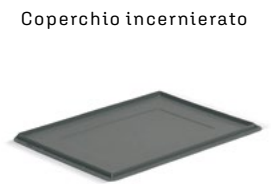

Coperchio incernierato

Dimensioni  
**400 x 300 mm**

AT 43HG 5401  
Confezione pz. 10  
Prezzo unitario **€ 3,36**

### ACCESSORI



Coppia ganci di chiusura integrabili con sigillo di sicurezza

AT LOCK 8113  
Confezione pz. 10  
Prezzo unitario **€ 0,38**



Molla blocco documenti in acciaio

SPRING 0099  
Confezione pz. 10  
Prezzo unitario **€ 0,33**



L'Ecogreen rappresenta una soluzione ecologica poiché dona nuova vita alla plastica riciclata derivante dalla valorizzazione dei rifiuti plastici da post consumo.

### SERIE 600x400



Dimensioni  
**600 x 400 x 120 h mm**

AT 6412A 5401  
Confezione pz. 4  
Prezzo unitario **€ 10,49**



Dimensioni  
**600 x 400 x 170 h mm**

AT 6417A 5401  
Confezione pz. 3  
Prezzo unitario **€ 12,48**



Dimensioni  
**600 x 400 x 220 h mm**

AT 6422A 5401  
Confezione pz. 2  
Prezzo unitario **€ 15,73**



Dimensioni  
**600 x 400 x 280 h mm**

AT 6428A 5401  
Confezione pz. 2  
Prezzo unitario **€ 18,33**



Dimensioni  
**600 x 400 x 325 h mm**

AT 6432A 5401  
Confezione pz. 3  
Prezzo unitario **€ 20,45**

Coperchio incernierato

Dimensioni  
**600 x 400 mm**

AT 64HG 5401  
Confezione pz. 10  
Prezzo unitario **€ 6,69**

16

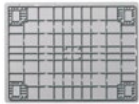

Fondo rinforzato  
**PORTATA 60 KG**

### SERIE 800x600



con piedini



con traverse



con ruote



Coperchio separato

Dimensioni  
**800 x 600 x 120 h mm**

Dimensioni  
**800 x 600 x 170 h mm**

Dimensioni  
**800 x 600 x 220 h mm**

Dimensioni  
**800 x 600 x 320 h mm**

Dimensioni  
**800 x 600 x 430 h mm**

Dimensioni  
**800 x 600 mm**

COLORE	800 x 600 x 120 h mm		800 x 600 x 170 h mm		800 x 600 x 220 h mm		800 x 600 x 320 h mm		800 x 600 x 430 h mm		800 x 600 mm	
	AT	8612C 5101	AT	8617C 5101	AT	8622C 5101	AT	8632C 5101	AT	8643C 5101	AT	86SE 5101
AT	8612C 51XB	AT	8617C 51XB	AT	8622C 51XB	AT	8632C 51XB	AT	8643C 51XB	AT	86SE 51XB	
	Confezione pz. 4		Confezione pz. 3		Confezione pz. 2		Confezione pz. 2		Confezione pz. 1		Confezione pz. 5	
	Prezzo unitario € 31,67		Prezzo unitario € 34,09		Prezzo unitario € 35,26		Prezzo unitario € 40,01		Prezzo unitario € 46,27		Prezzo unitario € 13,06	

## ACCESSORI



Piede h 100 mm



Traversa h 25 mm



Molla blocco documenti  
in acciaio



senza freno



con freno



senza freno

COLORE	Piede h 100 mm		Traversa h 25 mm		Molla blocco documenti in acciaio		senza freno		con freno		senza freno	
	AT	FEET 5101	AT	RUNN 5101	SPRING 0099		AT	WRCF 100	AT	WRBT 100	AT	WRCT 100
AT	FEET 51XB	AT	RUNN 51XB									
	Ordinare 4 piedi		Ordinare 2 pezzi				Ordinare 4 ruote		Ordinare 4 ruote		Ordinare 4 ruote	
	Accessori forniti montati		Accessori forniti montati		Confezione pz. 10		Accessori forniti montati		Accessori forniti montati		Accessori forniti montati	
	Prezzo unitario € 3,77		Prezzo unitario € 5,03		Prezzo unitario € 0,33		Prezzo unitario € 8,93		Prezzo unitario € 14,13		Prezzo unitario € 11,43	

### SERIE 400x300



Coperchio incernierato



Dimensioni  
**400 x 300 x 220 h mm**

Dimensioni  
**400 x 300 mm**

Dimensioni  
**600 x 400 x 120 h mm**

Dimensioni  
**600 x 400 x 220 h mm**

Dimensioni  
**600 x 400 x 325 h mm**

Dimensioni  
**600 x 400 mm**

COLORE	400 x 300 x 220 h mm		400 x 300 mm		600 x 400 x 120 h mm		600 x 400 x 220 h mm		600 x 400 x 325 h mm		600 x 400 mm	
	AT	4322A ISO	AT	43HG ISO	AT	6412A ISO	AT	6422A ISO	AT	6432A ISO	AT	64HG ISO
	Confezione pz. 4		Confezione pz. 10		Confezione pz. 4		Confezione pz. 2		Confezione pz. 3		Confezione pz. 10	
	Prezzo unitario € 13,64		Prezzo unitario € 5,42		Prezzo unitario € 16,43		Prezzo unitario € 26,20		Prezzo unitario € 34,09		Prezzo unitario € 10,76	

## ATHENA ISO

Marchiatura NON CONFORME - NON-COMPLIANT





Carrello realizzato in polipropilene ad alto impatto, adatto al trasporto di contenitori 600x400 e 400x300. Possibilità di essere impilato quando non in uso grazie ad un semplice sistema di collegamento è possibile creare file di carrelli per un'unica movimentazione.



Dimensioni  
**594 x 396 x 173 h mm**

### MO HELM

Timone telescopico regolabile in altezza

Confezione pz. 1

Prezzo unitario **€ 42,05**



SISTEMA DI COLLEGAMENTO



IMPILAGGIO

### MO 64TP 5107

4 ruote girevoli in termoplastico grigio ø 100 mm

Confezione pz. 1

Prezzo unitario **€ 48,68**

Carrello in polipropilene con ruote in nylon, adatto al trasporto di contenitori 800x600, 600x400 e 400x300.



SISTEMA DI BLOCCAGGIO

Dimensioni  
**800 x 600 x 196 h mm**

### MO 86NY 5101

2 ruote girevoli ø 80 mm  
2 ruote fisse ø 100 mm

Confezione pz. 1

Prezzo unitario **€ 239,25**

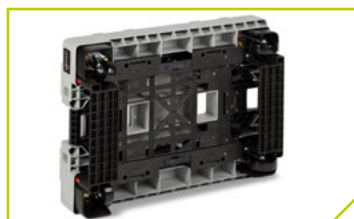

2 RUOTE GIREVOLI E 2 FISSE



# KRONOS

## SPACE SAVER



Le cassette abbattibili **KRONOS** sono state specificatamente progettate e realizzate per ridurre sensibilmente lo spazio di ingombro quando non utilizzate e nel trasporto dei vuoti. La riduzione del loro volume fino al **75%** consente quindi un elevato risparmio nei costi di immagazzinaggio e di trasporto.

18



### RIDUZIONE DEL VOLUME FINO AL 75%

SERIE  
**400x300**



Dimensioni  
**400 x 300 x 220 h mm**

KR 4322B 51XB  
Confezione pz. 10  
Prezzo unitario **€ 22,68**

SERIE  
**600x400**



Dimensioni  
**600 x 400 x 220 h mm**

KR 6422B 51XB  
Confezione pz. 5  
Prezzo unitario **€ 27,96**

SERIE  
**600x400**



Dimensioni  
**600 x 400 x 320 h mm**

KR 6432B 51XB  
Confezione pz. 5  
Prezzo unitario **€ 33,12**



**400 x 300 x 220h mm**



**600 x 400 x 220h mm**



**600 x 400 x 320h mm**

### PRESTO DISPONIBILE

- **600 x 400 x 420 h mm**
- **800 x 400 x 420 h mm**

### ABBATTIBILITÀ



### ACCESSORI



Coperchio incernierato  
a due falde

KR 43HG 51XB  
**400 x 300 mm**

Confezione pz. 5

Prezzo unitario **€ 3,55**



Coperchio incernierato  
a due falde

KR 64HG 51XB  
**600 x 400 mm**

Confezione pz. 5

Prezzo unitario **€ 5,64**



Carter di chiusura maniglie

KR PLUG 5125

Confezione pz. 10

Prezzo unitario **€ 0,34**



Sigillo monouso di sicurezza

KR SEAL 5113

Confezione pz. 500

Prezzo unitario **€ 0,10**

# DELTA

## SPACE SAVER



Le cassette serie **DELTA** presentano una struttura tronco-conica: a pieno carico sono sovrapponibili in modo stabile e sicuro, a vuoto si inseriscono l'una dentro l'altra con una riduzione del **70%** del loro volume. Per queste caratteristiche vengono utilizzate per consentire l'ideale sfruttamento degli spazi in magazzino e soprattutto nel trasporto.

ACCESSORI



Coperchio separato

DE 64SE 5101

DE 64SE 51XB

Confezione pz. 1

Prezzo unitario € 10,82



Sigillo monouso di sicurezza

DE SEAL 5113

Confezione pz. 500

Prezzo unitario € 0,10



RIDUZIONE DEL VOLUME  
**FINO AL 70%**

19

VERSIONE

**A**



Dimensioni  
**600 x 400 x 225 h mm**

DE 6422A 5101

DE 6422A 51XB

Confezione pz. 5

Prezzo unitario € 13,87



Dimensioni  
**600 x 400 x 325 h mm**

DE 6432A 5101

DE 6432A 51XB

Confezione pz. 4

Prezzo unitario € 18,58



Dimensioni  
**600 x 400 x 425 h mm**

DE 6442A 5101

DE 6442A 51XB

Confezione pz. 3

Prezzo unitario € 23,93

VERSIONE

**I**



Dimensioni  
**600 x 400 x 230 h mm**

DE 6422I 5101

DE 6422I 51XB

Confezione pz. 5

Prezzo unitario € 18,90



Dimensioni  
**600 x 400 x 330 h mm**

DE 6432I 5101

DE 6432I 51XB

Confezione pz. 4

Prezzo unitario € 23,63



Dimensioni  
**600 x 400 x 430 h mm**

DE 6442I 5101

DE 6442I 51XB

Confezione pz. 3

Prezzo unitario € 29,00

VERSIONE

**Z**



Dimensioni  
**600 x 400 x 240 h mm**

DE 6422Z 5101

DE 6422Z 51XB

Confezione pz. 5

Prezzo unitario € 26,78



Dimensioni  
**600 x 400 x 340 h mm**

DE 6432Z 5101

DE 6432Z 51XB

Confezione pz. 3

Prezzo unitario € 31,52



Dimensioni  
**600 x 400 x 440 h mm**

DE 6442Z 5101

DE 6442Z 51XB

Confezione pz. 3

Prezzo unitario € 36,84



# MINERVA

## SPACE SAVER



Le cassette serie **MINERVA** presentano una struttura tronco-conica: a pieno carico sono sovrapponibili in modo stabile e sicuro, a vuoto si inseriscono l'una dentro l'altra con una riduzione del **60%** del loro volume. Per queste caratteristiche vengono utilizzate per consentire l'ideale sfruttamento degli spazi in magazzino e soprattutto nel trasporto.

20



**RIDUZIONE DEL VOLUME  
FINO AL 60%**

### SERIE 600x400



Dimensioni  
**600 x 400 x 200 h mm**

COLORE	MI 6420B 5101
	MI 6420B 51XB
	MI 6420B 5900
Confezione pz.  6	
Prezzo unitario <b>€ 12,92</b>	

Dimensioni  
**600 x 400 x 300 h mm**

COLORE	MI 6430B 5101
	MI 6430B 51XB
	MI 6430B 5900
Confezione pz.  4	
Prezzo unitario <b>€ 19,43</b>	

Dimensioni  
**600 x 400 x 400 h mm**

COLORE	MI 6440B 5101
	MI 6440B 51XB
	MI 6440B 5900
Confezione pz.  3	
Prezzo unitario <b>€ 24,84</b>	



Coperchio separato



Dimensioni  
**600 x 400 mm**

COLORE	MI 64SE 5101
	MI 64SE 51XB
	MI 64SE 5900
Confezione pz.  1	
Prezzo unitario <b>€ 9,07</b>	



Molla blocco documenti  
in acciaio

SPRING	0099
Confezione pz.  10	
Prezzo unitario <b>€ 0,33</b>	



Molla blocco coperchio

MI LOCK	0099
Confezione pz.  10	
Prezzo unitario <b>€ 0,27</b>	

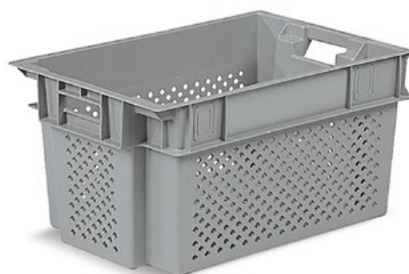

**DISPONIBILE ANCHE  
VERSIONE FORATA**

# CONTAINER

## LOGISTIC



**CONTAINER** stampati ad iniezione e realizzati in Polietilene Alta Densità (PEHD) e rigenerato (R-PE), anche per uso alimentare. Materiale completamente riciclabile, di prima fusione garantito e certificato. Facilmente lavabile ed inattaccabile dalla ruggine; insensibile a variazioni di peso a contatto con l'acqua. Particolarmente resistente ai raggi U.V. ed infrarossi, alle alte e basse temperature, agli acidi ed alcali. Strutturato in maniera da essere impilabile, per agevolare le operazioni di stoccaggio e di movimentazione.

21



Rigenerato



Rigenerato



Rigenerato



Dimensioni  
**1000x640x655hmm**

Dimensioni  
**1000x640x655hmm**

Dimensioni  
**1165x790x800hmm**

Dimensioni  
**1165x790x800hmm**

Dimensioni  
**1165x790x800hmm**

Dimensioni  
**1165x790x800hmm**

CN 1006FJ 4001

CN 1006FJ 4007

CN 1107FJ 4001

CN 1107FJ 4007

CN 1107SJ 4001

CN 1107SJ 4007

Volume 280 litri

Volume 280 litri

Volume 520 litri

Volume 520 litri

Volume 520 litri

Volume 520 litri

Portata 150 kg

Portata 150 kg

Portata 250 kg

Portata 250 kg

Portata 250 kg

Portata 250 kg

Prezzo unitario € 78,71

Prezzo unitario € 64,21

Prezzo unitario € 160,02

Prezzo unitario € 134,13

Prezzo unitario € 168,82

Prezzo unitario € 141,89



**SPEDIZIONE IN 7 GIORNI**

Fornito con ruote montate



4x ruote girevoli  
Ø 100 mm senza freno



4x ruote girevoli  
Ø 125 mm senza freno

Dimensioni  
**1000x640x790hmm**

Dimensioni  
**1165x790x960hmm**

CN 1006R1J 4001

CN 1107R2J 4001

Volume 280 litri

Volume 520 litri

Portata 150 kg

Portata 250 kg

Prezzo unitario € 149,85

Prezzo unitario € 234,13



Coperchio separato

Dimensioni  
**1000 x 640 mm**

CN CV10 4001

Confezione pz. 1

Prezzo unitario € 35,21



Coperchio separato

Dimensioni  
**1165 x 790 mm**

CN CV11 4001

Confezione pz. 1

Prezzo unitario € 43,50



Raccolta

Batterie esauste



Raccolta

Batterie esauste



Coperchio separato

Dimensioni  
**1200x1000x760hmm**

Dimensioni  
**1200 x 1000 mm**

CN 1210BJ 4001

Volume 610 litri

Portata 450 kg

Prezzo unitario € 229,51

CN CV12 4001

Confezione pz. 1

Prezzo unitario € 55,93

innovative  
italian  
ideas  
**imilani**

I carrelli portaminuteria **FOX** sono configurabili in diverse opzioni a seconda delle proprie necessità di stoccaggio. Disponibili con altezza 1430 mm, i carrelli **FOX** sono forniti di serie con ruote montate per facilitarne lo spostamento. Possono essere configurati in versione mono o bifronte e completati con mensole e cassette Compat, Zeus, Athena, Tekno o contenitori Practibox.



Dimensione carrello  
**1023 x 613 x 1430 h mm**

FXT B001 5401

Prezzo unitario € 509,65

**Contenitori in ECOGREEN**

**Completo di:**

<b>3 x</b>	Mensole inclinabili - prof. 420 mm
	Portata mensola <b>50 KG</b>

**CONTENITORI**

<b>9 x</b>	ATHENA 400 x 300 x 170 h mm
<b>2 x</b>	ATHENA 600 x 400 x 170 h mm



Dimensione carrello  
**725 x 613 x 1430 h mm**

FXT S001 5401

Prezzo unitario € 803,54

**Contenitori in ECOGREEN**

**Completo di:**

<b>6 x</b>	Mensole inclinabili - prof. 220 mm
	Portata mensola <b>50 KG</b>

**CONTENITORI**

<b>4 x</b>	PRACTIBOX 6 CASSETTI + FERMI
<b>4 x</b>	PRACTIBOX 5 CASSETTI + FERMI
<b>12 x</b>	ATHENA 300 x 200 x 120 h mm



Dimensione carrello  
**1023 x 613 x 1430 h mm**

FXT B002 5401

Prezzo unitario € 785,05

**Contenitori in ECOGREEN**

**Completo di:**

<b>5 x</b>	Mensole inclinabili - prof. 320 mm
	Portata mensola <b>50 KG</b>
<b>9 x</b>	Mensole fisse
	Portata mensola <b>25 KG</b>

**CONTENITORI**

<b>45 x</b>	COMPAT MISURA 1
<b>24 x</b>	COMPAT MISURA 2
<b>6 x</b>	ATHENA 400 x 300 x 120 h mm
<b>4 x</b>	ATHENA 400 x 300 x 170 h mm



Dimensione carrello  
**725 x 613 x 1430 h mm**

FXT S002 5401

Prezzo unitario € 424,33

**Contenitori in ECOGREEN**

**Completo di:**

<b>3 x</b>	Mensole inclinabili - prof. 420 mm
	Portata mensola <b>50 KG</b>

**CONTENITORI**

<b>4 x</b>	ATHENA 400 x 300 x 170 h mm
<b>1 x</b>	ATHENA 600 x 400 x 170 h mm
<b>1 x</b>	ATHENA 600 x 400 x 220 h mm



Dimensione carrello  
**1023 x 613 x 1430 h mm**

FXT B003 5401

Prezzo unitario € 719,39

**Contenitori in ECOGREEN**

**Completo di:**

<b>15 x</b>	Mensole fisse
	Portata mensola <b>25 KG</b>

**CONTENITORI**

<b>45 x</b>	COMPAT MISURA 1
<b>24 x</b>	COMPAT MISURA 2
<b>28 x</b>	COMPAT MISURA 3A2



Dimensione carrello  
**725 x 613 x 1430 h mm**

FXT S003 5401

Prezzo unitario € 867,55

**Contenitori in ECOGREEN**

**Completo di:**

<b>14 x</b>	Mensole inclinabili - prof. 220 mm
	Portata mensola <b>50 KG</b>

**CONTENITORI**

<b>30 x</b>	COMPAT MISURA 1
<b>44 x</b>	COMPAT MISURA 2

# SCOPRI

## LA GAMMA DI STRUTTURE PORTA CONTENITORI IN PRONTA CONSEGNA



**QUICK**



**FRAME**



**PICK**

Disponibile con

ATHENA

KRONOS

TEKNO



**QUICK**



**FRAME**

Disponibile con

COMPAT

ZEUS



**PICK**

Altezze disponibili

1000 / 1655 / 2000 h mm

**RICHIEDI UN PREVENTIVO**

[www.imilani.com](http://www.imilani.com)

**Varietà**



**PIÙ DI 1500 PRODOTTI  
DISPONIBILI A MAGAZZINO**

**Velocità**

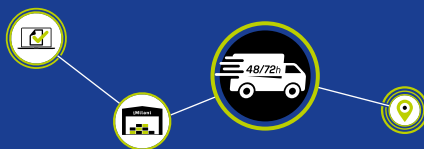

**SPEDIZIONI IN 48/72 ore**

**Qualità**



**5 ANNI DI GARANZIA SU  
TUTTI I PRODOTTI**

**RIVENDITORE AUTORIZZATO IMILANI**

**iMilani**

innovative  
italian  
ideas

**iMilani srl**

Via Capitano Alessio, 109  
36027 Rosà (VI) - Italy

Tel +39 0424 583100  
info@imilani.it  
www.imilani.com

A brand of:  
**i'M**



**RICHIEDI IL CATALOGO GENERALE**